

I9400W4 - January 27, 2021

Item # I9400W4 was discontinued on January 27, 2021 For informational purposes, this is a copy of the website content at that time and is valid only for the stated product.

MIR FREE-SPACE ISOLATORS (2.20 - 9.80 MM)

- ▶ Center Wavelengths from 2.3 to 4.5 μm or 9.4 μm
- ▶ Minimum Isolation of 29 dB or Higher
- ▶ Beam Sizes up to $\varnothing 3.6$ mm
- ▶ Custom Isolators Available Upon Request



OVERVIEW

Features

- Minimize Feedback into Optical Systems
- Free-Space Input and Output Ports
- Minimum Isolation of 29 dB or Higher at Center Wavelength
- Tunable Center Wavelength
- Beam Sizes up to $\varnothing 3.6$ mm
- Polarization-Dependent Input

Custom Isolators

- Customizable Wavelength, Aperture, Max Power, Housing, Polarizers, and Operating Temperature
- Pricing Similar to Stock Units
- Wide Range of OEM Capabilities
- Please Contact Tech Support or See Our Custom Isolators Page

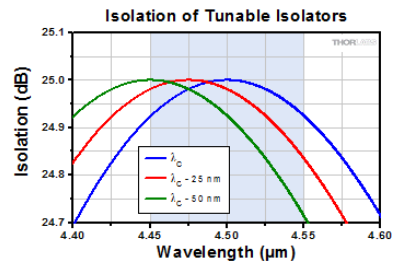

Click to Enlarge
 Our Adjustable Narrowband Isolators can be tuned to maximize the peak isolation for any wavelength within a narrow spectral range (shaded in this graph based on theoretical data). Please see the *Wavelength Tuning* tab for more details.

Thorlabs' Free-Space Adjustable Narrowband MIR Optical Isolators are designed for use in the MIR spectral range (2.20 - 9.80 μm). Optical isolators, also known as Faraday isolators, are magneto-optic devices that preferentially transmit light along a single direction, shielding upstream optics from back reflections. Back reflections can create a number of instabilities in light sources, including intensity noise, frequency shifts, mode hopping, and loss of mode lock. In addition, intense back-reflected light can permanently damage optics. Please see the *Isolator Tutorial* tab for an explanation of the operating principles of a Faraday isolator.

Selection Guide for Isolators (Click Here for Our Full Selection)	
Free-Space Isolators	
Spectral Region	Wavelength Range
UV	365 - 385 nm
Visible	390 - 700 nm

These isolators are factory aligned to provide peak isolation at the specified center wavelength. They also offer the user the ability to adjust the alignment of the output polarizer with respect to the input polarizer, allowing the peak of the isolation curve to lie anywhere within a 50 - 200 nm range; see the tables below for details. Please see the *Isolator Types* tab for additional design details and representative graphs of the wavelength-dependent isolation.



NIR	690 - 1080 nm
Nd:YAG	1064 nm
IR	1110 - 2100 nm
MIR	2.20 - 9.80 μm
Broadband Free-Space Isolators	
Fiber Isolators	
Custom Isolators	

Each isolator's housing is marked with an arrow that indicates the direction of forward propagation. In addition, all isolators have engravings that indicate the alignment of the input and output polarizers. The isolators can be mounted in a variety of adapters; compatible mounting options are listed with each product as well as at the bottom of the page.

Click to Enlarge
[APPLIST]
[APPLIST]
Isolators can be mounted close to the breadboard surface.

Thorlabs also manufactures isolators for fiber optic systems and wavelengths extending down to the UV (see the Selection Guide table to the left). If Thorlabs does not stock an isolator suited for your application, please refer to the *Custom Isolators* tab for information on our built-to-order options, or

contact Tech Support. Thorlabs' in-house manufacturing service has over 25 years of experience and can deliver a free-space isolator tuned to your center wavelength from 244 nm to 9.80 μm . Our vertically integrated manufacturing structure allows us to offer Faraday rotators used in optical isolators. We offer a selection of these products from stock and can provide custom Faraday rotators upon request.

GRAPHS

The shaded region on each graph below represents the wavelength tuning range of the isolator. The peaks of the isolation and transmission curves can be shifted anywhere within this range by rotating the output polarizer, as detailed in the *Wavelength Tuning* tab. These curves show theoretical data; isolation and transmission will vary from unit to unit.

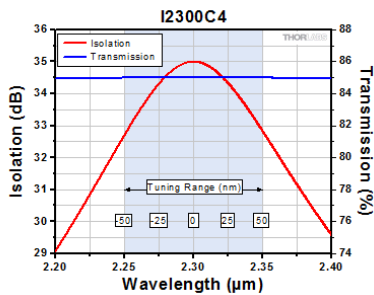

Click to Enlarge

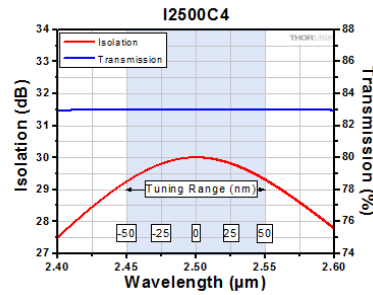

Click to Enlarge

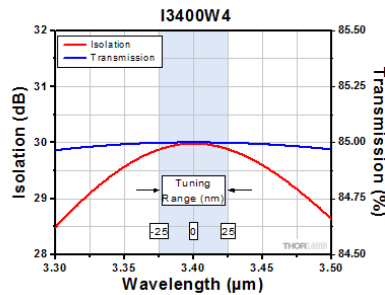

Click to Enlarge

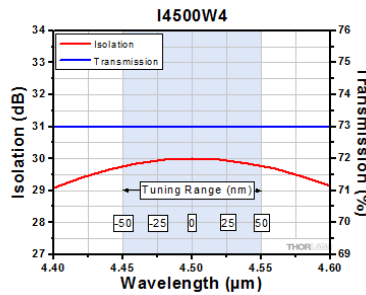

Click to Enlarge

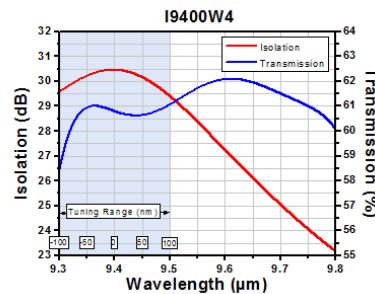

Click to Enlarge

WAVELENGTH TUNING

Tuning an Adjustable Narrowband Isolator

- Optimize our isolators to provide the same peak isolation anywhere within their tuning range.
- The simple tuning procedure, illustrated below, consists primarily of rotating the output polarizer.
- Slight transmission losses occur due to the rotation of the polarizer.

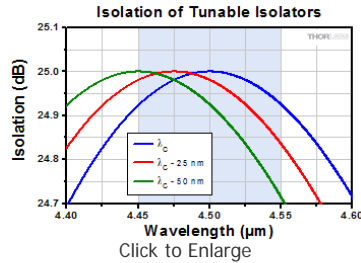

Our Adjustable Narrowband Isolators can be tuned to maximize the peak isolation for any wavelength within a narrow spectral range (shaded in this graph).

Operating Principles of Optical Isolators

Thorlabs' Adjustable Narrowband Isolators are designed to provide the same peak isolation anywhere within a 50 - 100 nm tuning range. They contain a Faraday rotator that has been factory tuned to rotate light of the design wavelength by 45°. Light propagating through the isolator in the backward direction is polarized at 45° by the output polarizer and is rotated by 45° by the Faraday rotator, giving a net polarization of 90° relative to the transmission axis of the input polarizer. Therefore, an isolator rejects backward propagating light. See the *Isolator Tutorial* tab for a schematic of the beam path.

The magnitude of the rotation caused by the Faraday rotator is wavelength dependent. This means that light with a different wavelength than the design wavelength will not be rotated at exactly 45°. For example, if 4.5 μm light is rotated by 45° (that is, 4.5 μm is the design wavelength), then 4.45 μm light is rotated by 45.4°. If 4.45 μm light is sent backward through an isolator designed for 4.5 μm without any tweaking, it will have a net polarization of 45° + 45.4° = 90.4° relative to the axis of the input polarizer. The polarization component of the light parallel to the input polarizer's axis will be transmitted, and the isolation will therefore be reduced.

Since the net polarization needs to be 90° to obtain the maximum isolation, the output polarizer is rotated to compensate for the extra rotation being caused by the Faraday isolator. In our example, the new polarizer angle is 90° - 45.4° = 44.6°. This adjustment increases the isolation back to the same value as at the design wavelength.

Consequences of Wavelength Tuning Procedure

As a direct consequence of rotating the output polarizer, the maximum transmission in the forward direction decreases. 4.45 μm light propagating in the forward direction is polarized at 0° by the input polarizer and rotated by 45.4° by the Faraday rotator, but the output polarizer is now at 44.6°. The amount of the transmission decrease can be quantified using Malus' Law:

$$I = I_0 \cos^2 \theta$$

Malus' Law

Here, θ is the angle between the polarization direction of the light after the Faraday rotator and the transmission axis of the polarizer, I_0 is the incident intensity, and I is the transmitted intensity. The decrease in transmission is very slight for our mid-IR isolators. In our example (a 50 nm difference between the design wavelength and the usage wavelength), $\theta = 45.4^\circ - 44.6^\circ = 0.8^\circ$, so $I = 0.9998 I_0$. This case is shown in the graphs above.

Thorlabs' isolator housings make it easy to rotate the output polarizer without disturbing the rest of the isolator. Our custom isolator manufacturing service (see the *Custom Isolators* tab) can also provide an isolator specifically designed for a particular center wavelength. These custom isolators are provided at the same cost as their equivalent stock counterparts. For more information, please contact Technical Support.

Illustrated Tuning Procedure

To optimize the isolation curve for a specific wavelength within the tuning range, the alignment of the output polarizer may be tweaked following the simple procedure outlined below. Only a minor adjustment is necessary to cover a range of tens of nanometers. An isolator need only be fine-tuned once it has undergone its mandatory initial alignment. The fine-tuning process differs slightly for different isolator packages, but the principle remains the same across our entire isolator family, and complete model-specific tuning instructions ship with each isolator.

Step 1:

Orient the isolator so that the arrows on the housing are pointing towards the laser.

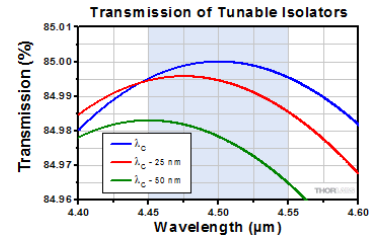

When the isolator is tuned away from its design wavelength, the maximum transmission falls because the output polarizer's transmission axis is not parallel to the polarization direction of the output light.

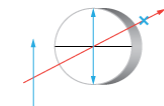

Click to Enlarge
Light at the Design
Wavelength is
Rejected

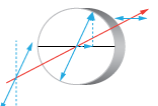

Click to Enlarge
Light Not at the Design
Wavelength is Partially
Transmitted



Click to Enlarge



Click to Enlarge



Click to Enlarge



Click to Enlarge

Step 2:

Place the isolator in a compatible mounting adapter, such as an SM05RC slip ring (mounting adapters shown below). A power meter with high sensitivity at low power levels should be placed after the isolator.

Secure the isolator in the mounting adapter by tightening the locking screw hex on the adapter. Note that the isolator should be secured in a way that exposes the polarizer tuning setscrew.

The isolator is mechanically stable in this position as long as the isolator has not been brought forward too much. It should therefore not be necessary to reinsert the isolator at the end of the tuning procedure.

Step 3:

Loosen the exposed tuning setscrew using the provided 0.050" hex key. At this point, the output polarizer will be free to rotate.

Step 4:

Rotate the output polarizer to minimize the power on the power meter. As explained above, the necessary adjustment should be less than 1°. Tighten the tuning setscrew once optimization is achieved.

As long as the isolator was not brought forward too much at the end of Step 3, the isolator will be mechanically stable in this position. Attempting to reinsert the isolator at this point may cause misalignment.

ISOLATOR TYPES

Fixed Narrowband Isolator

The isolator is set for 45° of rotation at the design wavelength. The polarizers are non-adjustable and are set to provide maximum isolation at the design wavelength. As the wavelength changes the isolation will drop; the graph shows a representative profile.

- Fixed Rotator Element, Fixed Polarizers
- Polarization Dependent
- Smallest and Least Expensive Isolator Type
- No Tuning

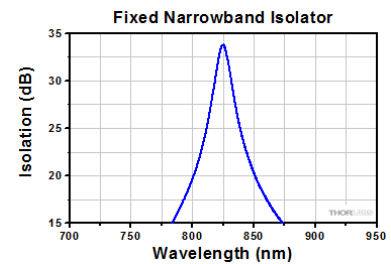

Adjustable Narrowband Isolator

The isolator is set for 45° of rotation at the design wavelength. If the usage wavelength changes, the Faraday rotation will change, thereby decreasing the isolation. To regain maximum isolation, the output polarizer can be rotated to "re-center" the isolation curve. This rotation causes transmission losses in the forward direction that increase as the difference between the usage wavelength and the design wavelength grows.

- Fixed Rotator Element, Adjustable Polarizers
- Polarization Dependent
- General-Purpose Isolator

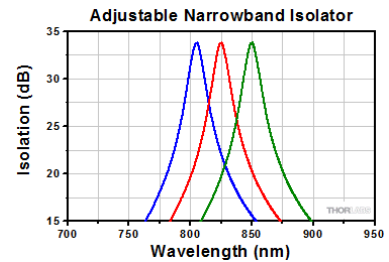

Adjustable Broadband Isolator

The isolator is set for 45° of rotation at the design wavelength. There is a tuning ring on the isolator that adjusts the amount of Faraday rotator material that is inserted into the internal magnet. As your usage wavelength changes, the Faraday rotation will change, thereby decreasing the isolation. To regain maximum isolation, the tuning ring is adjusted to produce the 45° of rotation necessary for maximum isolation.

- Adjustable Rotator Element, Fixed Polarizers
- Polarization Dependent
- Simple Tuning Procedure
- Broader Tuning Range than Adjustable Narrowband Isolators

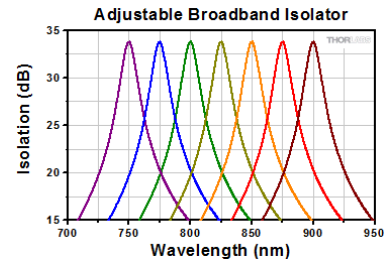

Fixed Broadband Isolator

A 45° Faraday rotator is coupled with a 45° crystal quartz rotator to produce a combined 90° rotation on the output. The wavelength dependences of the two rotator materials work together to produce a flat-top isolation profile. The isolator does not require any tuning or adjustment for operation within the designated design bandwidth.

- Fixed Rotator Element, Fixed Polarizers
- Polarization Dependent
- Largest Isolation Bandwidth
- No Tuning Required

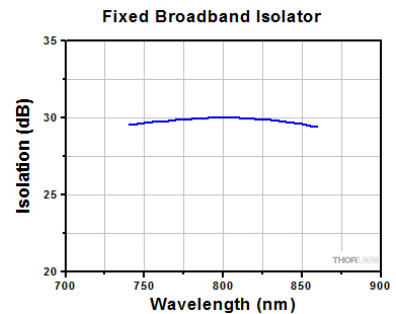

Tandem Isolators

Tandem isolators consist of two Faraday rotators in series, which share one central polarizer. Since the two rotators cancel each other, the net rotation at the output is 0°. Our tandem designs yield narrowband isolators that may be fixed or adjustable.

- Up to 60 dB Isolation
- Polarization Dependent
- Highest Isolation
- Fixed or Adjustable

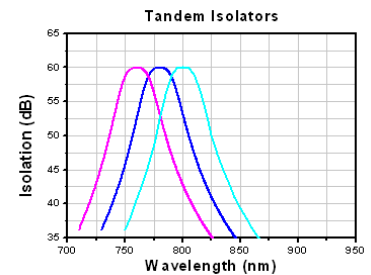

POLARIZER COMPARISON

Polarizer Types, Sizes, and Power Limits

Thorlabs designs and manufactures several types of polarizers that are used across our family of optical isolators. Their design characteristics are detailed below. The part number of given isolator has an identifier for the type of polarizer that isolator contains. For more details on how the part number describes each isolator, see the given isolator's manual.

Polarizer Comparison			
Type	Schematic (Click to Enlarge)	Maximum Power Density	Description
Very Low Power (C)		10 W/cm ² (CW, Blocking) 25 W/cm ² (CW, Transmission)	Our Very Low Power Absorptive Film Polarizers are compact options for isolating free-space beams. For light polarized perpendicular to the polarizer's transmission axis, the max power density is 10 W/cm ² , while for light polarized parallel to the polarizer's transmission axis, the max power density is 25 W/cm ² .
			These polarizers are also for use with very low power sources but are made with a

Very Low Power (VLP)		25 W/cm ² (CW, Blocking) 100 W/cm ² (CW, Transmission)	different material than the type C polarizers listed above. This gives these polarizers a higher maximum power density. For light polarized perpendicular to the polarizer's transmission axis, the max power density is 25 W/cm ² , while for light polarized parallel to the polarizer's transmission axis, the max power density is 100 W/cm ² .
Wire Grid (W)		25 W/cm ² (CW)	Wire Grid Polarizers are used in our mid-IR isolators. They consist of a linearly spaced wire grid pattern that is deposited onto an AR-coated silicon substrate.
Polarizing Beamsplitter (PBS)		13 - 50 W/cm ² (CW)	Polarizing Beamsplitter Cubes are commonly used in low-power applications and feature an escape window useful for monitoring or injection locking.
α-BBO Glan-Laser (GLB)		100 W/cm ² (CW)	Thorlabs' α-BBO Glan-Laser polarizers are all based on high-grade, birefringent, α-BBO crystals with a wavelength range of 210 - 450 nm. Due to the birefringent structure of α-BBO, a phase delay is created between two orthogonally polarized waves traveling in the crystal. These are similar to the High Power (HP) polarizers, but have a different escape angle.
Low Power (LP)		250 W/cm ² (CW) 25 MW/cm ² (Pulsed)	Our Low Power Polarizers are Glan-type, crystal polarizers, providing high transmission and power densities at the expense of a larger package than Very Low Power (VLP) and Polarizing Beamsplitter (PBS) polarizers.
Medium Power (MP)		100 W/cm ² (CW) 50 MW/cm ² (Pulsed)	Medium Power Polarizers are Glan-type, crystal polarizers, capable of handling higher powers. The rejected beam is internally scattered, which reduces the maximum power density, but also eliminates a stray beam from the setup.
High Power (HP)		500 W/cm ² (CW) 150 MW/cm ² (Pulsed)	High Power Polarizers are Glan-type, crystal polarizers, similar in size and transmission to Medium Power (MP) polarizers, but capable of handling higher powers. They feature an escape window suited for injection locking.
Yttrium Orthovanadate (YV)		25 W/cm ² (CW)	YV polarizers are similar to the Medium Power (MP) Glan-type crystal polarizers; however, by using yttrium orthovanadate (YVO ₄) rather than calcite, YV polarizers can accommodate wavelengths in the 2.0 - 3.4 μm range. The rejected beam is internally scattered, which reduces the maximum power density, but also eliminates a stray beam from the setup.
Very High Power (VHP)		20 kW/cm ² (CW) 2 GW/cm ² (Pulsed)	Our Very High Power Polarizers are based on Brewster windows and feature the highest power handling possible. These polarizers have larger packages than HP-based designs, but are also more economical. All VHP-based designs also feature escape windows.

ISOLATOR TUTORIAL

Optical Isolator Tutorial

Function

An optical isolator is a passive magneto-optic device that only allows light to travel in one direction. Isolators are used to protect a source from back reflections or signals that may occur after the isolator. Back reflections can damage a laser source or cause it to mode hop, amplitude modulate, or frequency shift. In high-power applications, back reflections can cause instabilities and power spikes.

An isolator's function is based on the Faraday Effect. In 1842, Michael Faraday discovered that the plane of polarized light rotates while transmitting through glass (or other materials) that is exposed to a magnetic field. The direction of rotation is dependent on the direction of the magnetic field and not on the direction of light propagation; thus, the rotation is non-reciprocal. The amount of rotation β equals $V \times B \times d$, where V , B , and d are as defined below.

Faraday Rotation

$$\beta = V \times B \times d$$

V: the Verdet Constant, a property of the optical material, in radians/T • m.

B: the magnetic flux density in teslas.

d: the path length through the optical material in meters.

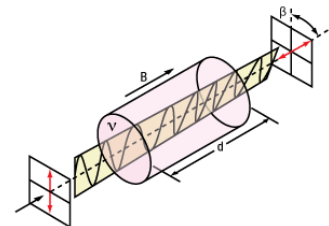

Figure 1. Faraday Rotator's Effect on Linearly Polarized Light

An optical isolator consists of an input polarizer, a Faraday rotator with magnet, and an output polarizer. The input polarizer works as a filter to allow only linearly polarized light into the Faraday rotator. The Faraday element rotates the input light's polarization by 45°, after which it exits through another linear polarizer. The output light is now rotated by 45° with respect to the input signal. In the reverse direction, the Faraday rotator continues to rotate the light's

polarization in the same direction that it did in the forward direction so that the polarization of the light is now rotated 90° with respect to the input signal. This light's polarization is now perpendicular to the transmission axis of the input polarizer, and as a result, the energy is either reflected or absorbed depending on the type of polarizer.

Polarization-Dependent Isolators

The Forward Mode

In this example, we will assume that the input polarizer's axis is vertical (0° in Figure 2). Laser light, either polarized or unpolarized, enters the input polarizer and becomes vertically polarized. The Faraday rotator will rotate the plane of polarization (POP) by 45° in the positive direction. Finally, the light exits through the output polarizer which has its axis at 45°. Therefore, the light leaves the isolator with a POP of 45°.

In a dual-stage isolator, the light exiting the output polarizer is sent through a second Faraday rotator followed by an additional polarizer in order to achieve greater isolation than a single-stage isolator.

The Reverse Mode

Light traveling backwards through the isolator will first enter the output polarizer, which polarizes the light at 45° with respect to the input polarizer. It then passes through the Faraday rotator rod, and the POP is rotated another 45° in the positive direction. This results in a net rotation of 90° with respect to the input polarizer, and thus, the POP is now perpendicular to the transmission axis of the input polarizer. Hence, the light will either be reflected or absorbed.

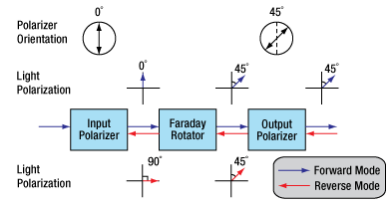

Figure 2. A single-stage, polarization-dependent isolator. Light propagating in the reverse direction is rejected by the input polarizer.

Polarization-Independent Fiber Isolators

The Forward Mode

In a polarization independent fiber isolator, the incoming light is split into two branches by a birefringent crystal (see Figure 3). A Faraday rotator and a half-wave plate rotate the polarization of each branch before they encounter a second birefringent crystal aligned to recombine the two beams.

In a dual-stage isolator, the light then travels through an additional Faraday rotator, half-wave plate, and birefringent beam displacer before reaching the output collimating lens. This achieves greater isolation than the single-stage design.

The Reverse Mode

Back-reflected light will encounter the second birefringent crystal and be split into two beams with their polarizations aligned with the forward mode light. The Faraday rotator is a non-reciprocal rotator, so it will cancel out the rotation introduced by the half wave plate for the reverse mode light. When the light encounters the input birefringent beam displacer, it will be deflected away from the collimating lens and into the walls of the isolator housing, preventing the reverse mode from entering the input fiber.

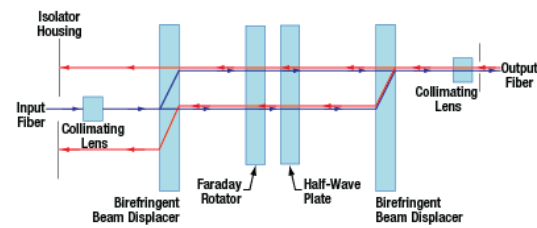

Figure 3. A single-stage, polarization-independent isolator. Light is deflected away from the input path and stopped by the housing.

General Information

Damage Threshold

With 25 years of experience and 5 U.S. patents, our isolators typically have higher transmission and isolation than other isolators, and are smaller than other units of equivalent aperture. For visible to YAG laser Isolators, Thorlabs' Faraday Rotator crystal of choice is TGG (terbium-gallium-garnet), which is unsurpassed in terms of optical quality, Verdet constant, and resistance to high laser power. Thorlabs' TGG Isolator rods have been damage tested to 22.5 J/cm² at 1064 nm in 15 ns pulses (1.5 GW/cm²), and to 20 kW/cm² CW. However, Thorlabs does not bear responsibility for laser power damage that is attributed to hot spots in the beam.

Magnet

The magnet is a major factor in determining the size and performance of an isolator. The ultimate size of the magnet is not simply determined by magnetic field strength but is also influenced by the mechanical design. Many Thorlabs magnets are not simple one piece magnets but are complex assemblies. Thorlabs' modeling systems allow optimization of the many parameters that affect size, optical path length, total rotation, and field uniformity. Thorlabs' US Patent 4,856,878 describes one such design that is used in several of the larger aperture isolators for YAG lasers. Thorlabs emphasizes that a powerful magnetic field exists around these Isolators, and thus, steel or magnetic objects should not be brought closer than 5 cm.

Dispersion Measurement of Isolator IO-5-780-HP

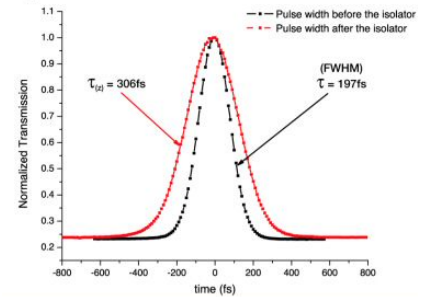

Figure 4. Pulse Dispersion Measurements Before and After an IO-5-780-HP Isolator

Temperature

The magnets and the Faraday rotator materials both exhibit a temperature dependence. Both the magnetic field strength and the Verdet Constant decrease with increased temperature. For operation greater than $\pm 10^\circ\text{C}$ beyond room temperature, please contact Technical Support.

Pulse Dispersion

Pulse broadening occurs anytime a pulse propagates through a material with an index of refraction greater than 1. This dispersion increases inversely with the pulse width and therefore can become significant in ultrafast lasers.

τ : Pulse Width Before Isolator

$\tau_{(z)}$: Pulse Width After Isolator

Example:

$t = 197\text{ fs}$ results in $t_{(z)} = 306\text{ fs}$ (pictured to the right)

$t = 120\text{ fs}$ results in $t_{(z)} = 186\text{ fs}$

ISOLATOR GUIDE

The following selection guide contains all of Thorlabs' Free-Space Optical Isolators. Click the colored bars below to see specifications and options for each wavelength range and isolator type. Please note that Thorlabs also offers fiber optical isolators and custom optical isolators.

Free-Space Optical Isolator Selection Guide

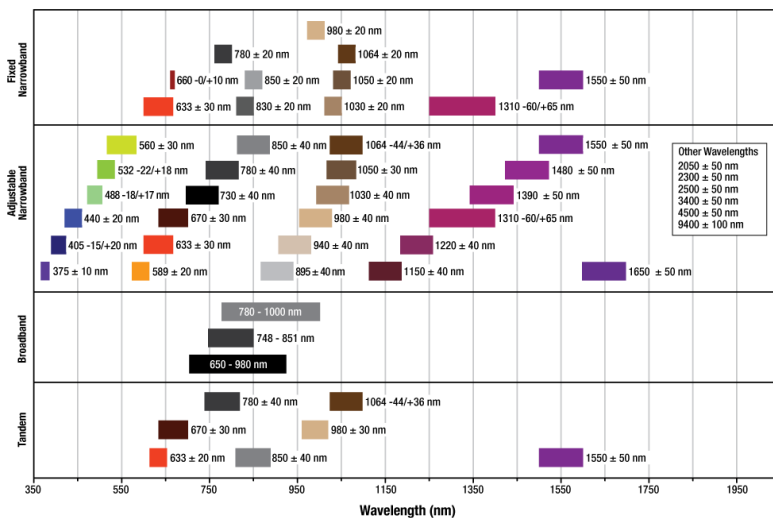

2.3 μm Polarization-Dependent Isolator



Click to Enlarge



Item #	I2300C4
Type	Adjustable Narrowband
Center Wavelength	2.3 μm
Tuning Range	2.25 - 2.35 μm
Operating Range	2.20 - 2.40 μm
Transmission^a	85%
Isolation^a	35 dB (Min)
Performance Graph (Click for Details)	
Max Beam Diameter^b	3.6 mm
Max Power^c	1.2 W
Max Power Density^d	10 W/cm ² (CW, Blocking) 25 W/cm ² (CW, Transmission)
Compatible Mounting Adapters^e	FBS05 SM05RC (SM05RC/M) SM05TC

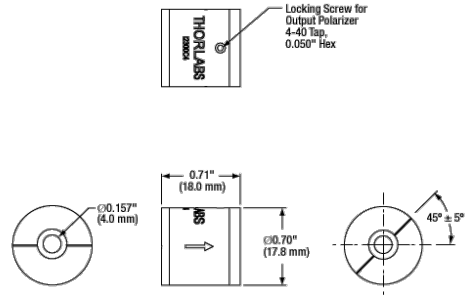

I2300C4 Mechanical Drawing

- a. Specified at center wavelength. See Performance Graph for wavelength dependence.
- b. Defined as containing 100% of the beam energy.
- c. The maximum power specification represents the maximum power for the combined forward and reverse directions for a Gaussian beam. Therefore, the sum of the powers in the forward and reverse directions cannot exceed the maximum power specification.
- d. The blocking power density corresponds to light polarized perpendicular to the transmission axis, while the transmission power density corresponds to light polarized parallel to the transmission axis.
- e. Please see below for more information on compatible mounting adapters.

Part Number	Description	Price	Availability
I2300C4	Free-Space Isolator, 2.3 μm , 3.6 mm Max Beam, 1.2 W Max	\$2,227.89	Today

2.5 μm Polarization-Dependent Isolator

Click to Enlarge



Item #	I2500C4
Type	Adjustable Narrowband
Center Wavelength	2.5 μm
Tuning Range	2.45 - 2.55 μm
Operating Range	2.40 - 2.60 μm

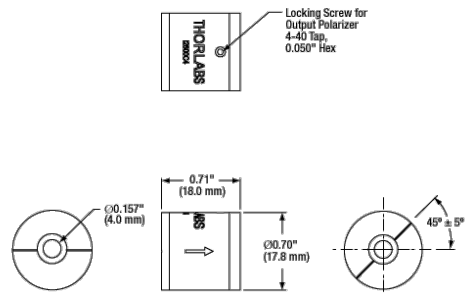

I2500C4 Mechanical Drawing

Transmission^a	83%
Isolation^a	30 dB (Min)
Performance Graph (Click for Details)	
Max Beam Diameter^b	3.6 mm
Max Power^c	1.2 W
Max Power Density^d	10 W/cm ² (CW, Blocking) 25 W/cm ² (CW, Transmission)
Compatible Mounting Adapters^e	FBS05 SM05RC (SM05RC/M) SM05TC

- a. Specified at center wavelength. See Performance Graph for wavelength dependence.
- b. Defined as containing 100% of the beam energy.
- c. The maximum power specification represents the maximum power for the combined forward and reverse directions for a Gaussian beam. Therefore, the sum of the powers in the forward and reverse directions cannot exceed the maximum power specification.
- d. The blocking power density corresponds to light polarized perpendicular to the transmission axis, while the transmission power density corresponds to light polarized parallel to the transmission axis.
- e. Please see below for more information on compatible mounting adapters.

Part Number	Description	Price	Availability
I2500C4	Free-Space Isolator, 2.5 μm , 3.6 mm Max Beam, 1.2 W Max	\$3,193.31	Today

3.4 μm Polarization-Dependent Isolator

Click to Enlarge	
Item #	I3400W4
Type	Adjustable Narrowband
Center Wavelength	3.4 μm
Tuning Range	3.375 - 3.425 μm
Operating Range	3.350 - 3.450 μm
Transmission^a	85%
Isolation^a	30 dB
Performance Graph (Click for Details)	
Max Beam Diameter^b	3.6 mm
Max Power^c	1.2 W
Max Power Density	25 W/cm ²
Compatible Mounting Adapters^d	FBS05 SM05RC (SM05RC/M) SM05TC

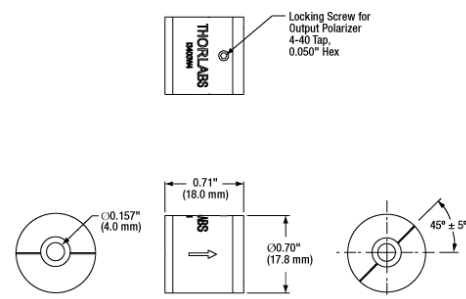

I3400W4 Mechanical Drawing

- a. Specified at center wavelength. See Performance Graph

for wavelength dependence.

- b. Defined as containing 100% of the beam energy.
- c. The maximum power specification represents the maximum power for the combined forward and reverse directions for a Gaussian beam. Therefore, the sum of the powers in the forward and reverse directions cannot exceed the maximum power specification.
- d. Please see below for more information on compatible mouting adapters.

Part Number	Description	Price	Availability
I3400W4	Customer Inspired! Free-Space Isolator, 3.4 μm, 3.6 mm Max Beam, 1.2 W Max	\$2,652.25	Today

4.5 μm Polarization-Dependent Isolator

Click to Enlarge	
Item #	I4500W4
Type	Adjustable Narrowband
Center Wavelength	4.5 μm
Tuning Range	4.45 - 4.55 μm
Operating Range	4.45 - 4.55 μm
Transmission ^a	73%
Isolation ^a	30 dB
Performance Graph (Click for Details)	
Max Beam Diameter ^b	3.6 mm
Max Power ^c	1 W
Max Power Density	25 W/cm ²
Compatible Mounting Adapters ^d	FBS05 SM05RC (SM05RC/M) SM05TC

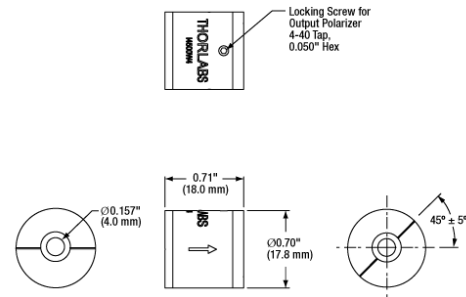

I4500W4 Mechanical Drawing

- a. Specified at center wavelength. See Performance Graph for wavelength dependence.
- b. Defined as containing 100% of the beam energy.
- c. The maximum power specification represents the maximum power for the combined forward and reverse directions for a Gaussian beam. Therefore, the sum of the powers in the forward and reverse directions cannot exceed the maximum power specification.
- d. Please see below for more information on compatible mouting adapters.

Part Number	Description	Price	Availability
I4500W4	Customer Inspired! Free-Space Isolator, 4.5 μm, 3.6 mm Max Beam, 1 W Max	\$3,978.38	Lead Time

9.4 μm Polarization-Dependent Isolator

--	--

Click to Enlarge

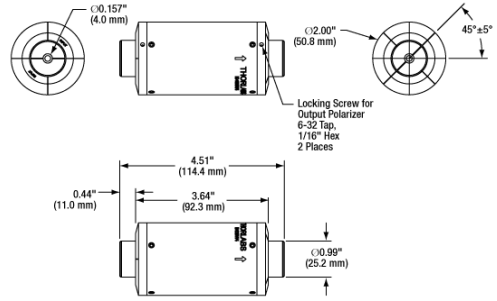

I9400W4 Mechanical Drawing

Item #	I9400W4
Type	Adjustable Narrowband
Center Wavelength	9.4 μm
Tuning Range	9.30 - 9.50 μm
Operating Range	9.30 - 9.80 μm
Transmission ^a	60% (Min)
Isolation ^a	29 dB (Min)
Performance Graph (Click for Details)	
Max Beam Diameter ^b	3.6 mm
Max Power ^c	400 mW
Max Power Density	25 W/cm ²
Compatible Mounting Adapters ^d	C2RC (C2RC/M) SM3B2

- a. Specified at center wavelength. See Performance Graph for wavelength dependence.
- b. Defined as containing 100% of the beam energy.
- c. The maximum power specification represents the maximum power for the combined forward and reverse directions for a Gaussian beam. Therefore, the sum of the powers in the forward and reverse directions cannot exceed the maximum power specification.
- d. Please see below for more information on compatible mounting adapters.

Part Number	Description	Price	Availability
I9400W4	Customer Inspired! Free-Space Isolator, 9.4 μm , 3.6 mm Max Beam, 400 mW Max	\$4,243.60	Lead Time

Isolator Mounting Adapters

These adapters provide mechanical compatibility between our isolator bodies and $\text{\O}1/2$ " posts, $\text{\O}1$ " posts, or FiberBench systems.

Click Image to Enlarge					
Item #	FBS05	SM05RC(M)	SM05TC	SM3B2	C2RC(M)
Isolator Diameter	0.70"	0.70"	0.70"	2.0"	2.0"
Mounting Options	FiberBench Systems	$\text{\O}1/2$ " Posts	$\text{\O}1/2$ " Posts	SM3 Lens Tubes	$\text{\O}1/2$ " Posts or $\text{\O}1$ " Posts
Compatible Isolators	I2300C4, I2500C4, I3400W4, I4500W4			I9400W4	

Part Number	Description	Price	Availability
SM05RC/M	Slip Ring for SM05 Lens Tubes, M4 Tap	\$21.31	Today
C2RC/M	Slip Ring for $\text{\O}2$ " ($\text{\O}50.8$ mm) Components, M4 Tap	\$40.86	Today
FBS05	FiberBench $\text{\O}1/2$ " Lens Tube Mount	\$50.86	Today

SM05TC	Clamp for SM05 Lens Tubes	\$42.20	Today
SM3B2	Ø2.0" Isolator to SM3 Adapter	\$38.95	Today
SM05RC	Slip Ring for SM05 Lens Tubes, 8-32 Tap	\$21.31	Today
C2RC	Slip Ring for Ø2" (Ø50.8 mm) Components, 8-32 Tap	\$40.86	Today

