

1500-CAB1 - December 02, 2019

Item # 1500-CAB1 was discontinued on December 02, 2019. For informational purposes, this is a copy of the website content at that time and is valid only for the stated product.

1.4 MEGAPIXEL CCD SCIENTIFIC CAMERAS FOR MICROSCOPY

- ▶ 1.4 Megapixel Monochrome and Color CCD Cameras
- ▶ Scientific-Grade Cameras with $<7 e^-$ Read Noise
- ▶ Up to 23 Frames per Second for the Full Sensor
- ▶ Support for LabVIEW, MATLAB, μ Manager, and MetaMorph



1501C-GE-TE
 Hermetically Sealed
 Two-Stage Cooled Color Camera



Application Idea
 1501M-USB Non-Cooled Monochrome
 Camera with C-Mount Camera Lens



Scientific CCD Camera in a Cerna® Microscope

OVERVIEW

Features

- High Quantum Efficiency Maximizes Signal and SNR (60% Peak Quantum Efficiency in Monochrome Versions)
- $<6 e^-$ (TEC Cooled) or $<7 e^-$ (Non-Cooled) Read Noise Improves the Threshold of Detectability Under Low Light Conditions
- Software-Selectable 20 MHz or 40 MHz Readout: Maximize Frame Rate (40 MHz) or Minimize Noise (20 MHz)
- Asynchronous Reset, Triggered, and Bulb Exposure Modes (See *Triggering* Tab for Details)
- 2/3" Format, 1392 x 1040 Monochrome or Color CCD Sensor with 6.45 μ m Square Pixels (Sony ICX285AL or ICX285AQ)
- ThorCam GUI with 32- and 64-Bit Windows® 7 or 10 Support
- SDK and Programming Interfaces Provide Support for:
 - C, C++, C#, Python, and Visual Basic .NET APIs
 - LabVIEW, MATLAB, μ Manager, and MetaMorph Third-Party Software

Applications

- Fluorescence Microscopy
- VIS/NIR Imaging
- Quantum Dots
- Multispectral Imaging
- Immunohistochemistry (IHC)
- Histopathology
- Retinal Imaging
- Fluorescence *In Situ* Hybridization (FISH)

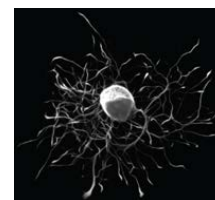

Click to Enlarge
 This fluorescence image of a rat neuron was acquired using one of our 1.4 MP cameras. For more image samples, please see the *Applications* tab.

Thorlabs' 1.4 megapixel scientific CCD cameras, which offer up to 23 frames per second at 40 MHz readout of the full sensor, are specifically designed for microscopy and other demanding scientific imaging applications. These cameras are ideal for multispectral imaging, fluorescence microscopy, and other techniques that would benefit from high quantum efficiency and low noise.

Scientific Camera Selection Guide

Compact Scientific	Quantalux® 2.1 MP sCMOS ($<1 e^-$ Read Noise)
	Kiralux™ 2.3 MP CMOS
	Kiralux 5 MP CMOS
	Kiralux 5 MP CMOS, Polarization Sensitive
	Kiralux 8.9 MP CMOS
	1.4 MP CCD



Click to Enlarge
1501M-GE Camera Integrated into
60 mm Cage System



Click to Enlarge
1501M-USB Camera with
MVL25M23 C-Mount Camera
Lens

Standard Package or Hermetically Sealed TE-Cooled Camera

Our cameras are available in two package styles: a compact, non-cooled standard package and a hermetically sealed package with a two-stage thermoelectric cooler that cools the CCD. The fan-free design minimizes image blur from vibrations. Cooling the camera will reduce the dark current; however, the total dark current is also a function of exposure time. For high light levels requiring short exposure times (less than 1 second), a non-cooled camera is generally sufficient. A cooled camera is recommended for applications with low light levels requiring an exposure greater than 1 second. Please see the *Camera Noise* tab for more details on the various sources of camera noise and how they impact the choice between a standard and cooled camera.

USB 3.0, Gigabit Ethernet, or Camera Link Industry-Standard Interfaces

Thorlabs' scientific cameras are offered with a choice of USB 3.0, Gigabit Ethernet (GigE), or Camera Link interface. GigE is ideal for situations where the camera must be far from the PC or there are multiple cameras that need to be controlled by the same PC. The GigE and Camera Link cameras are provided with either a GigE or Camera Link frame grabber card and cables. Since USB 3.0 is supported by most computers, the USB cameras do not come

Scientific CCD	4 MP CCD
	8 MP CCD
	VGA Resolution CCD (200 Frames Per Second)



Jason Mills
General Manager,
Thorlabs Scientific Imaging

Feedback?
Questions?
Need a Quote?

[Contact Me](#)

with a card, however one is available separately. A power supply and software are supplied with all cameras. More information on what's included is on the *Shipping List* tab. Your computer must have a free PCI Express slot to install the GigE or Camera Link interface. For more information on the three interface options and recommended computer specifications, please see the *Interface* tab.

Our cameras have triggering options that enable custom timing and system control; for more details, please see the *Triggering* tab. External triggering requires a connection to the auxiliary port of the camera. Accessory cables and boards to "break out" the individual signals are available below.

Each camera comes with a user-removable IR filter; for details on the transmission please see the *Specs* tab. If the filter is removed, it can be replaced with a user-supplied $\varnothing 1"$ ($\varnothing 25$ mm) filter or another optic up to 4 mm thick; please see the camera manual (found under the red *Docs* icon below) for details.

The cameras feature standard C-Mount (1.000"-32) threading, and Thorlabs provides a full line of thread-to-thread adapters for compatibility with other thread standards, including the SM1 (1.035"-40) threading used on our $\varnothing 1"$ Lens Tubes. The front face also has 4-40 tapped holes for compatibility with our 60 mm Cage System. Four 1/4"-20 tapped holes, one on each side of the housing, are compatible with our $\varnothing 1"$ posts. These flexible mounting options make Thorlabs' scientific cameras the ideal choice for integrating into home-built imaging systems as well as those based on commercial microscopes.



S P E C S

Monochrome Item # ^a	1501M-USB	1501M-USB-TE	1501M-GE	1501M-GE-TE	1501M-CL	1501M-CL-TE
Color Item # ^a	1501C-USB	1501C-USB-TE	1501C-GE	1501C-GE-TE	1501C-CL	1501C-CL-TE
Sensor Type	Monochrome: Sony ICX285AL Monochrome CCD (Grade 0) Color: Sony ICX285AQ Color CCD (Grade 0)					
Effective Number of Pixels (Horizontal x Vertical)	1392 x 1040					
Imaging Area (Horizontal x Vertical)	8.98 mm x 6.71 mm					
Pixel Size	6.45 μ m x 6.45 μ m					
Optical Format	2/3" Format (11 mm Diagonal)					
Peak Quantum Efficiency	Monochrome: 60% at 500 nm Color: See Graph Below					
Exposure Time	0 to 1000 seconds in 1 ms Increments ^b					

CCD Pixel Clock Speed	20 MHz or 40 MHz					
ADC ^c Gain	0 to 1023 Steps (0.036 dB/Step)					
Optical Black Clamp	0 to 1023 Steps (0.25 ADU/Step) ^d					
Vertical Hardware Binning ^e	Continuous Integer Values from 1 to 24					
Horizontal Software Binning ^e	Continuous Integer Values from 1 to 24					
Region of Interest	1 x 1 Pixel to 1392 x 1040 Pixels, Rectangular					
Read Noise ^f	<7 e- at 20 MHz	<6 e- at 20 MHz	<7 e- at 20 MHz	<6 e- at 20 MHz	<7 e- at 20 MHz	<6 e- at 20 MHz
Digital Output	14 Bit					
Cooling	None	Sensor Cools to -20 °C at 20 °C Ambient Temperature	None	Sensor Cools to -20 °C at 20 °C Ambient Temperature	None	Sensor Cools to -20 °C at 20 °C Ambient Temperature
Host PC Interface ^g	USB 3.0		Gigabit Ethernet		Camera Link	
Lens Mount	C-Mount (1.000" -32)					

- The specified performance is valid when using a computer with the recommended specifications listed on the *Interface* tab.
- Exposure time varies with operating mode; exposure times shorter than 1 ms may be possible when using an external trigger.
- ADC = Analog-to-Digital Converter
- ADU = Analog-to-Digital Unit
- Camera Frame Rate is impacted by the Vertical Hardware Binning parameter. For color cameras, when the Image Type setting in ThorCam is anything other than "Unprocessed" only 1 x 1 binning is available. When set to Unprocessed, the camera can bin up to 24 x 24, but the image produced will be monochrome.
- If your application is read-noise limited, we recommend using the lower CCD pixel clock speed of 20 MHz. For more information about read noise, and for examples of how to calculate the limiting factor of total camera noise, please see the *Camera Noise* tab.
- * For more information on these interface options, please see the *Interface* tab.

Example Frame Rates at 1 ms Exposure Time ^a	20 MHz	40 MHz
Full Sensor (1392 x 1040)	12 fps	23 fps
Full Sensor, Bin by 2 (696 x 520)	23 fps	41 fps
Full Sensor, Bin by 10 (139 x 104)	77 fps	112 fps

- Camera Frame Rate is impacted by the Vertical Hardware Binning parameter. For color cameras, when the Image Type setting in ThorCam is anything other than "Unprocessed" only 1 x 1 binning is available. When set to Unprocessed, the camera can bin up to 24 x 24, but the image produced will be monochrome.

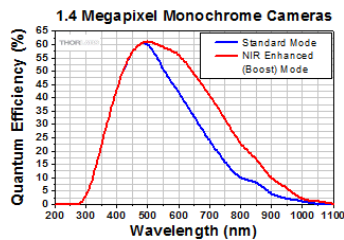

Click to Enlarge
Click for Raw Data

These curves show the quantum efficiency for the monochrome camera sensor. The NIR Enhanced (Boost) Mode can be selected via the software. The IR blocking filter should also be removed for maximum NIR sensitivity. Please note that the NIR Boost mode will reduce the antiblooming performance. Antiblooming reduces the effect of one overexposed pixel on neighboring pixels.

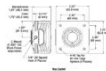

Click to Enlarge
Non-Cooled
Camera

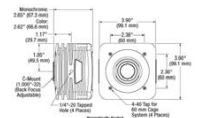

Click to Enlarge
Hermetically Sealed
Cooled Camera

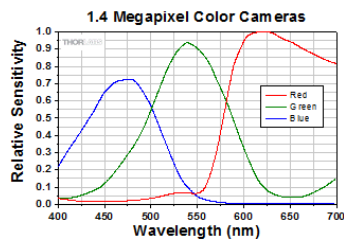

Click to Enlarge

These curves show the relative response for the color camera sensor's red, green, and blue pixels.

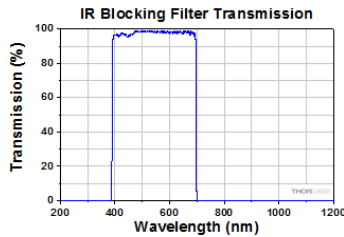

Click to Enlarge

Click for Raw Data

The IR blocking filter (Thorlabs' Item # FESH0700) can be removed from the camera; instructions are provided in the manual. If the filter is removed, it can be replaced with a user-supplied Ø1" (Ø25 mm) filter or another optic up to 4 mm thick.

APPLICATIONS

Thorlabs' Scientific-Grade CCD Cameras are ideal for a variety of applications. The photo gallery below contains images acquired with our 1.4 megapixel, 4 megapixel, 8 megapixel, and fast frame rate cameras.

To download some of these images as high-resolution, 16-bit TIFF files, please click here. It may be necessary to use an alternative image viewer to view the 16-bit files. We recommend ImageJ, which is a free download.

Thorlabs' Scientific Camera Applications (Click Images for Details)

Intracellular Dynamics	Brightfield Microscopy	Ophthalmology (NIR)	Fluorescence Microscopy	Multispectral Imaging	Neuroscience	SEM/TEM
Thorlabs' Scientific Camera Recommended for Above Application						
1.4 Megapixel Fast Frame Rate	4 Megapixel 8 Megapixel	1.4 Megapixel	4 Megapixel 1.4 Megapixel	4 Megapixel 1.4 Megapixel	1.4 Megapixel	1.4 Megapixel 4 Megapixel Fast Frame Rate

Multispectral Imaging

The video to the right is an example of a multispectral image acquisition using a liquid crystal tunable filter (LCTF) in front of a monochrome camera. With a sample slide exposed to broadband light, the LCTF passes narrow bands of light that are transmitted from the sample. The monochromatic images are captured using a monochrome scientific camera, resulting in a datacube – a stack of spectrally separated two-dimensional images which can be used for quantitative analysis, such as finding ratios or thresholds and spectral unmixing.

In the example shown, a mature *capsella bursa-pastoris* embryo, also known as Shepherd's-Purse, is rapidly scanned across the 420 nm - 730 nm wavelength range using Thorlabs' KURIOS-WB1 Liquid Crystal Tunable Filter. The images are captured using our 1501M-GE Scientific Camera, which is connected, with the liquid crystal filter, to a Cerna® Series Microscope. The overall system magnification is 10X. The final stacked/recovered image is shown below.

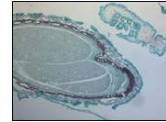

Click to Enlarge
Final
Stacked/Recovered
Image

Thrombosis Studies

Thrombosis is the formation of a blood clot within a blood vessel that will impede the flow of blood in the circulatory system. The videos below are from experimental studies on the large-vessel thrombosis in Mice performed by Dr. Brian Cooley at the Medical College of Wisconsin. Three lasers (532 nm, 594 nm, and 650 nm) were expanded and then focused on a microsurgical field of an exposed surgical site in an anesthetized mouse. A custom 1.4 Megapixel Camera with integrated filter wheel were attached to a Leica Microscope to capture the low-light fluorescence emitted from the surgical site. See the videos below with their associated descriptions for further information.

Arterial Thrombosis

In the video above, a gentle 30-second electrolytic injury is generated on the surface of a carotid artery in an atherogenic mouse (ApoE-null on a high-fat, "Western" diet), using a 100-micron-diameter iron wire (creating a free-radical injury). The site (arrowhead) and the vessel are imaged by time-lapse fluorescence-capture, low-light camera over 60 minutes (timer is shown in upper left corner – hours:minutes:seconds). Platelets were labeled with a green fluorophore (rhodamine 6G) and anti-fibrin antibodies with a red fluorophore (Alexa-647) and injected prior to electrolytic injury to identify the development of platelets and fibrin in the developing thrombus. Flow is from left to right; the artery is approximately 500 microns in diameter (bar at lower right, 350 microns).

Venous Thrombosis

In the video above, a gentle 30-second electrolytic injury is generated on the surface of a murine femoral vein, using a 100-micron-diameter iron wire (creating a free-radical injury). The site (arrowhead) and the vessel are imaged by time-lapse fluorescence-capture, low-light camera over 60 minutes (timer is shown in upper left corner – hours:minutes:seconds). Platelets were labeled with a green fluorophore (rhodamine 6G) and anti-fibrin antibodies with a red fluorophore (Alexa-647) and injected prior to electrolytic injury to identify the development of platelets and fibrin in the developing thrombus. Flow is from left to right; the vein is approximately 500 microns in diameter (bar at lower right, 350 microns).

Reference: Cooley BC. In vivo fluorescence imaging of large-vessel thrombosis in mice. *Arterioscler Thromb Vasc Biol* 31, 1351-1356, 2011. All animal studies were done under protocols approved by the Medical College of Wisconsin Institutional Animal Care and Use Committee.

Camera Back Panel Connector Locations

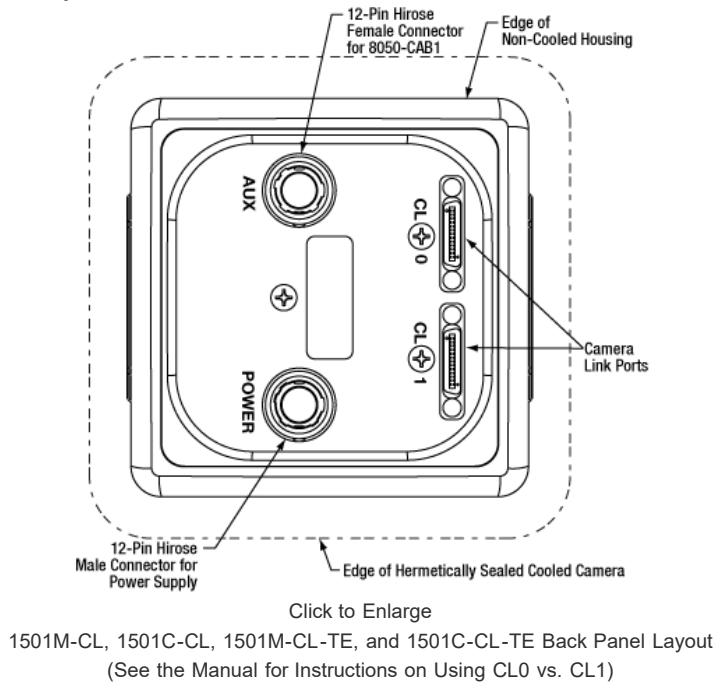
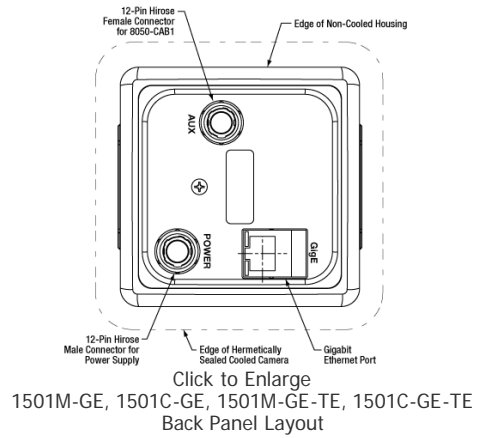
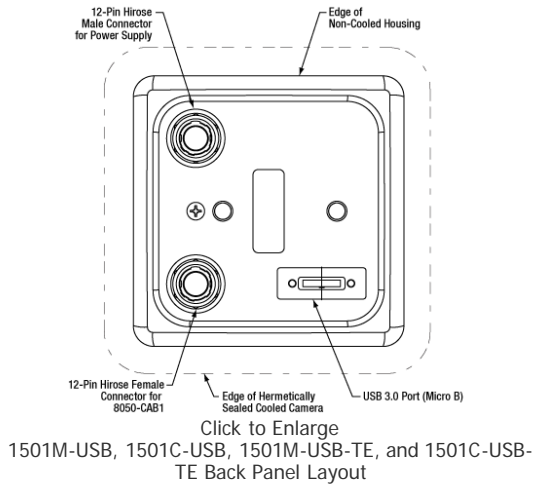

TSI-IOBOB and TSI-IOBOB2 Break-Out Board Connector Locations

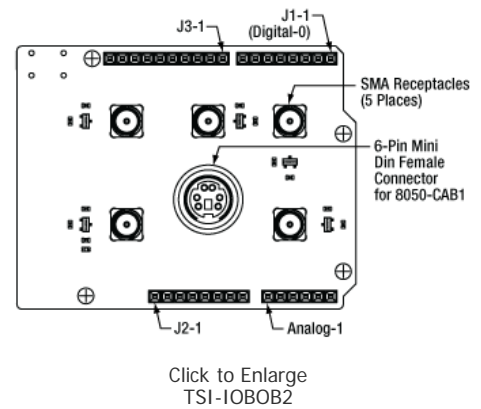
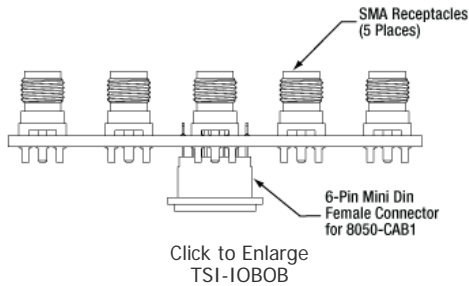

Auxiliary Connector

The cameras and the break-out boards

TSI-IOBOB and TSI-IOBOB2 Connector	8050-CAB1 Connectors	Camera Auxiliary (AUX) Port

both feature female connectors; the 8 megapixel cameras have a 12 pin Hirose connector, while the break out boards have a 6-pin Mini-DIN connector.

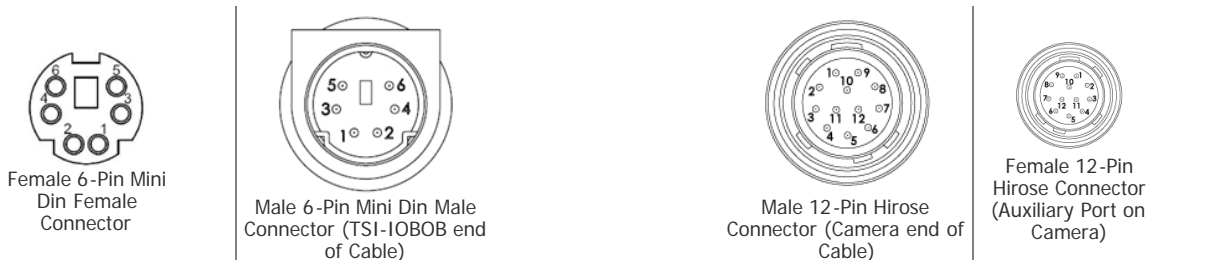

The 8050-CAB1 cable features male connectors on both ends: a 12-pin connector for connecting to the camera and a 6-pin Mini-DIN connector for the break-out boards. Pins 1, 2, 3, 5, and 6 are each connected to the center pin of an SMA connector on the break-out boards, while pin 4 (ground) is connected to each SMA connector housing. To access one of the I/O functions not available with the 8050-CAB1, the user must fabricate a cable using shielded cabling in order for the camera to adhere to CE and FCC compliance; additional details are provided in the camera manual.

Camera AUX Pin #	TSI-IOBOB and TSI-IOBOB2 Pin #	Signal	Description
1	-	Reserved	Reserved for future use
2	-	Reserved	Reserved for future use
3	-	Reserved	Reserved for future use
4	6	STROBE_OUT (Output)	A TTL output that is high during the actual sensor exposure time when in continuous, overlapped exposure mode. It is typically used to synchronize an external flash lamp or other device with the camera.
5	3	TRIGGER_IN (Input)	A TTL input used to trigger exposures on the transition from the high to low state.
6	1	LVAL (Output)	Refers to "Line Valid." It is an active-high TTL signal and is asserted during the valid period on each line. It returns low during the inter-line period between each line and during the inter-frame period between each frame.
7	2	TRIGGER_OUT (Output)	A 6 μ s positive pulse asserted when using the various external trigger input options; TRIGGER_IN, LVDS_TRIGGER_IN, or the CameraLink CC1 signal. The CC1 signal, driven from the host, is one of the software-controlled trigger signals for the camera. The CC1 signal is brought out of the camera as TRIGGER_OUT at the High-to-Low transition to allow triggering of other devices. The same applies to the other external triggers.
8	-	LVDS_TRIGGER_IN_N (Input, Differential Pair with Pin 9)	A LVDS (low-voltage differential signal) input used to trigger exposures on the transition from the high state to low state. The suffix "N" identifies this as the negative input of the LVDS signal.
9	-	LVDS_TRIGGER_IN_P (Input, Differential Pair with Pin 9)	A LVDS (low-voltage differential signal) input used to trigger exposures on the transition from the high state to low state. The suffix "P" identifies this as the positive input of the LVDS signal.
10	4	GND	The electrical ground for the camera signals
11	-	Reserved	Reserved for future use
12	5	FVAL_OUT (Output)	Refers to "Frame Valid." It is a TTL output that is high during active readout lines and returns low between frames.

SOFTWARE

ThorCam™

ThorCam is a powerful image acquisition software package that is designed for use with our cameras on 32- and 64-bit Windows® 7 or 10 systems. This intuitive, easy-to-use graphical interface provides camera control as well as the ability to acquire and play back images. Single image capture and image sequences are supported. Please refer to the screenshots below for an overview of the software's basic functionality.

Application programming interfaces (APIs) and a software development kit (SDK) are included for the development of custom applications by OEMs and developers. The SDK provides easy integration with a wide variety of programming languages, such as C, C++, C#, Python, and Visual Basic .NET. Support for third-party software packages, such as LabVIEW, MATLAB, and μ Manager is available. We also offer example Arduino code for integration with our TSI-IOBOB2 Interconnect Break-Out Board.

Recommended System Requirements ^a	
Operating System	Windows [®] 7 or 10 (64 Bit)
Processor (CPU) ^b	≥3.0 GHz Intel Core (i5 or Higher)
Memory (RAM)	≥8 GB
Hard Drive ^c	≥500 GB (SATA) Solid State Drive (SSD)
Graphics Card ^d	Dedicated Adapter with ≥256 MB RAM
Motherboard	USB 3.0 (-USB) Cameras: Integrated Intel USB 3.0 Controller or One Unused PCIe x1 Slot (for Item # USB3-PCIE) GigE (-GE) Cameras: One Unused PCIe x1 Slot Camera Link (-CL) Cameras: One Unused PCIe x4/x8/x16 Slot
Connectivity	USB or Internet Connectivity for Driver Installation

- ^aSee the Performance Considerations section below for recommendations to minimize dropped frames for demanding applications.
- ^bIntel Core i3 processors and mobile versions of Intel processors may not satisfy the requirements.
- ^cWe recommend a solid state drive (SSD) for reliable streaming to disk during image sequence storage.
- ^dOn-board/integrated graphics solutions present on Intel Core i5 and i7 processors are also acceptable.

Software

Version 3.3.1

Click the button below to visit the ThorCam software page.



Example Arduino Code for TSI-IOBOB2 Board

Click the button below to visit the download page for the sample Arduino programs for the TSI-IOBOB2 Shield for Arduino. Three sample programs are offered:

- Trigger the Camera at a Rate of 1 Hz
- Trigger the Camera at the Fastest Possible Rate
- Use the Direct AVR Port Mappings from the Arduino to Monitor Camera State and Trigger Acquisition



Click the Highlighted Regions to Explore ThorCam Features

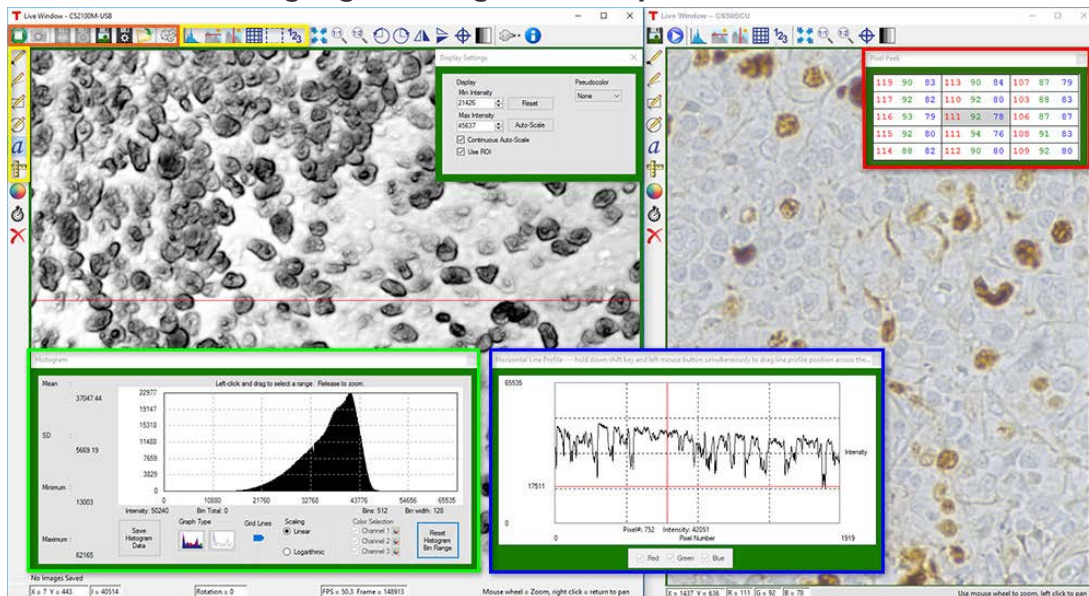

Camera Control and Image Acquisition

Camera Control and Image Acquisition functions are carried out through the icons along the top of the window, highlighted in orange in the image above. Camera parameters may be set in the popup window that appears upon clicking on the Tools icon. The Snapshot button allows a single image to be acquired using the current camera settings.

The Start and Stop capture buttons begin image capture according to the camera settings, including triggered imaging.

Timed Series and Review of Image Series

The Timed Series control, shown in Figure 1, allows time-lapse images to be recorded. Simply set the total number of images and the time delay in between captures. The output will be saved in a multi-page TIFF file in order to preserve the high-precision, unaltered image data. Controls within ThorCam allow the user to play the sequence of images or step through them frame by frame.

Measurement and Annotation

As shown in the yellow highlighted regions in the image above, ThorCam has a number of built-in annotation and measurement functions to help analyze images after they have been acquired. Lines, rectangles, circles, and freehand shapes can be drawn on the image. Text can be entered to annotate marked locations. A measurement mode allows the user to determine the distance between points of interest.

The features in the red, green, and blue highlighted regions of the image above can be used to display information about both live and captured images.

ThorCam also features a tally counter that allows the user to mark points of interest in the image and tally the number of points marked (see Figure 2). A crosshair target that is locked to the center of the image can be enabled to provide a point of reference.

Third-Party Applications and Support

ThorCam is bundled with support for third-party software packages such as LabVIEW, MATLAB, and .NET. Both 32- and 64-bit versions of LabVIEW and MATLAB are supported. A full-featured and well-documented API, included with our cameras, makes it convenient to develop fully customized applications in an efficient manner, while also providing the ability to migrate through our product line without having to rewrite an application.

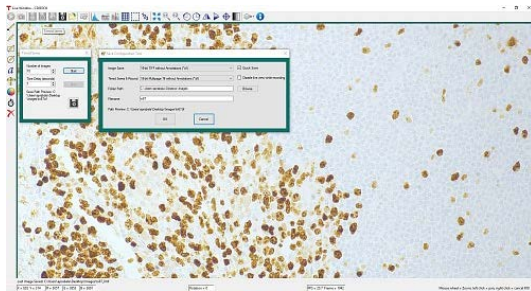

Click to Enlarge

Figure 1: A timed series of 10 images taken at 1 second intervals is saved as a multipage TIFF.

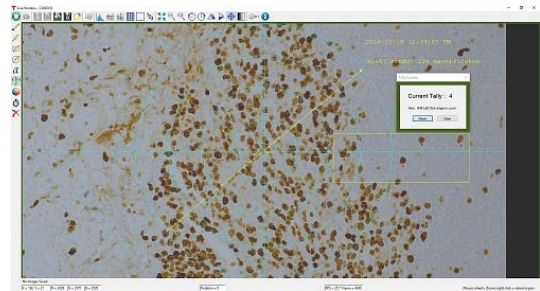

Click to Enlarge

Figure 2: A screenshot of the ThorCam Software. The tally function was used to mark three locations in the image. The line to the lower left was added using the measurement function, with the distance between the points in pixels displayed just above it.

Performance Considerations

Please note that system performance limitations can lead to "dropped frames" when image sequences are saved to the disk. The ability of the host system to keep up with the camera's output data stream is dependent on multiple aspects of the host system. Note that the use of a USB hub may impact performance. A dedicated connection to the PC is preferred. USB 2.0 connections are not supported.

First, it is important to distinguish between the frame rate of the camera and the ability of the host computer to keep up with the task of displaying images or streaming to the disk without dropping frames. The frame rate of the camera is a function of exposure and readout (e.g. clock, ROI) parameters. Based on the acquisition parameters chosen by the user, the camera timing emulates a digital counter that will generate a certain number of frames per second. When displaying images, this data is handled by the graphics system of the computer; when saving images and movies, this data is streamed to disk. If the hard drive is not fast enough, this will result in dropped frames.

One solution to this problem is to ensure that a solid state drive (SSD) is used. This usually resolves the issue if the other specifications of the PC are sufficient. Note that the write speed of the SSD must be sufficient to handle the data throughput.

Larger format images at higher frame rates sometimes require additional speed. In these cases users can consider implementing a RAID0 configuration using multiple SSDs or setting up a RAM drive. While the latter option limits the storage space to the RAM on the PC, this is the fastest option available. ImDisk is one example of a free RAM disk software package. It is important to note that RAM drives use volatile memory. Hence it is critical to ensure that the data is moved from the RAM drive to a physical hard drive before restarting or shutting down the computer to avoid data loss.

USB 3.0 Contents Example



Click to Enlarge
Item # Shown: 1501M-USB

In Addition to the Camera, Each USB3.0 Item Includes the following:

- USB 3.0 Cable (Micro B to A)
- Power Supply, with Region-Specific Power Cord
- Wrench to Loosen Optical Assembly
- Lens Mount Dust Cap (Also Functions as IR Filter Removal Tool)
- CD with ThorCam Software
- Quick-Start Guide and Manual Download Information Card

Gigabit Ethernet Contents Example



Click to Enlarge
Item # shown: 1501M-GE

In Addition to the Camera, Each GigE Item Includes the following:

- Gigabit Ethernet PCI Express Card
- Gigabit Ethernet Cable
- Power Supply, with Region-Specific Power Cord
- Wrench to Loosen Optical Assembly
- Lens Mount Dust Cap (Also Functions as IR Filter Removal Tool)
- CD with ThorCam Software
- Quick-Start Guide and Manual Download Information Card

Camera Link Contents Example



Click to Enlarge
Item # Shown: 1501M-CL

In Addition to the Camera, Each Camera Link Item Includes the following:

- Camera Link PCI Express Card
- One Camera Link Cable
- Power Supply, with Region-Specific Power Cord
- Wrench to Loosen Optical Assembly
- Lens Mount Dust Cap (Also Functions as IR Filter Removal Tool)
- CD with ThorCam Software
- Quick-Start Guide and Manual Download Information Card

Camera Noise and Temperature

Overview

When purchasing a camera, an important consideration is whether or not the application will require a cooled sensor. Generally, most applications have high signal levels and do not require cooling. However, for certain situations, generally under low light levels where long exposures are necessary, cooling will provide a benefit. In the tutorial below, we derive the following "rule of thumb": for exposures less than 1 second, a standard camera is generally sufficient; for exposures greater than 1 second, cooling could be beneficial; for exposures greater than 5 seconds, cooling is generally recommended; and for exposures above 10 seconds, cooling is usually required. If you have questions about which domain your application will fall, you might consider estimating the signal levels and noise sources by following the steps detailed in the tutorial below. Alternatively you can contact us, and one of our scientific camera specialists will help you decide which camera is right for you.

Sources of Noise

Noise in a camera image is the aggregate spatial and temporal variation in the measured signal, assuming constant, uniform illumination. There are several components of noise:

- **Dark Shot Noise (σ_D):** Dark current is a current that flows even when no photons are incident on the camera. It is a thermal phenomenon resulting from electrons spontaneously generated within the silicon chip (valence electrons are thermally excited into the conduction band). The variation in the amount of dark electrons collected during the exposure is the dark shot noise. It is independent of the signal level but is dependent on the temperature of the sensor as shown in Table 1.
- **Read Noise (σ_R):** This is the noise generated in producing the electronic signal. This results from the sensor design but can also be impacted by the design of the camera electronics. It is independent of signal level and temperature of the sensor, and is larger for faster CCD pixel clock rates.
- **Photon Shot Noise (σ_S):** This is the statistical noise associated with the arrival of photons at the pixel. Since photon measurement obeys Poisson statistics, the photon shot noise is dependent on the signal level measured. It is independent of sensor temperature.
- **Fixed Pattern Noise (σ_F):** This is caused by spatial non-uniformities of the pixels and is independent of signal level and temperature of the sensor. Note that fixed pattern noise will be ignored in the discussion below; this is a valid assumption for the CCD cameras sold here but may need to be included for other non-scientific-grade sensors.

Total Effective Noise

The total effective noise per pixel is the quadrature sum of each of the noise sources listed above:

$$\sigma_{eff} = \sqrt{\sigma_D^2 + \sigma_R^2 + \sigma_S^2} \quad (1)$$

Here, σ_D is the dark shot noise, σ_R is the read noise (typically less than 10 e- for scientific-grade cameras using the ICX285AL CCD; we will assume a value of 10 e- in this tutorial), and σ_S is the photon shot noise. If $\sigma_S \gg \sigma_D$ and $\sigma_S \gg \sigma_R$, then σ_{eff} is approximately given by the following:

$$\sigma_{eff} = \sqrt{\sigma_S^2} = \sigma_S \quad (2)$$

Again, fixed pattern noise is ignored, which is a good approximation for scientific-grade CCDs but may need to be considered for non-scientific-grade sensors.

Dark Shot Noise and Sensor Temperature

As mentioned above, the dark current is a thermal effect and can therefore be reduced by cooling the sensor. Table 1 lists typical dark current values for the Sony ICX285AL CCD sensor used in our 1.4 megapixel monochrome cameras. As the dark current results from spontaneously generated electrons, the dark current is measured by simply "counting" these electrons. Since counting electrons obeys Poisson statistics, the noise associated with the dark current I_D is proportional to the square root of the number of dark electrons that accumulate during the exposure. For a given exposure, the dark shot noise, σ_D , is therefore the square root of the I_D value from Table 1 (for a given sensor temperature) multiplied by the exposure time t in seconds:

$$\sigma_D = \sqrt{I_D t} \quad (3)$$

Temperature	Dark Current (I_D)
-20 °C	0.1 e-/(s•pixel)
0 °C	1 e-/(s•pixel)
25 °C	5 e-/(s•pixel)

Table 1: Nominal dark current values at several temperatures for the Sony ICX285AL CCD sensor.

Since the dark current decreases with decreasing temperature, the associated noise can be decreased by cooling the camera. For example, assuming an exposure of 5 seconds, the dark shot noise levels for the three sensor temperatures listed in the table are

$$\begin{aligned}\sigma_D(25\text{ }^\circ\text{C}) &= \sqrt{5 * 5} = 5\text{ e-} \\ \sigma_D(0\text{ }^\circ\text{C}) &= \sqrt{5 * 1} = 2.2\text{ e-} \\ \sigma_D(-20\text{ }^\circ\text{C}) &= \sqrt{5 * 0.1} = 0.7\text{ e-}\end{aligned}\quad (4)$$

Figure 1, which is a plot of the dark shot noise as a function of exposure for the three temperatures listed in Table 1, illustrates how the dark shot noise increases with increasing exposure. Figure 1 also includes a plot of the upper limit of the read noise.

If the photon shot noise is significantly larger than the dark shot noise, then cooling provides a negligible benefit in terms of the noise, and our standard package cameras will work well.

Photon Shot Noise

If S is the number of "signal" electrons generated when a photon flux of N photons/second is incident on each pixel of a sensor with a quantum efficiency QE and an exposure duration of t seconds, then

$$S = (QE)Nt \quad (5)$$

From S , the photon shot noise, σ_S , is given by:

$$\sigma_S = \sqrt{(QE)Nt} \quad (6)$$

Example Calculations

If we assume that there is a sufficiently high photon flux and quantum efficiency to allow for a signal S of 10,000 e^- to accumulate in a pixel with an exposure of 5 seconds, then the estimated shot noise, σ_S , would be the square root of 10,000, or 100 e^- . The read noise is 10 e^- (independent of exposure time). For an exposure of 5 seconds and sensor temperatures of 25, 0, and $-25\text{ }^\circ\text{C}$, the dark shot noise is given in equation (4). The effective noise is:

$$\begin{aligned}\sigma_{eff} &= \sqrt{\sigma_D^2 + \sigma_R^2 + \sigma_S^2} \\ \sigma_{eff}(25\text{ }^\circ\text{C}) &= \sqrt{5^2 + 10^2 + 100^2} = 100.6\text{ e-} \\ \sigma_{eff}(0\text{ }^\circ\text{C}) &= \sqrt{2.2^2 + 10^2 + 100^2} = 100.5\text{ e-} \\ \sigma_{eff}(-20\text{ }^\circ\text{C}) &= \sqrt{0.7^2 + 10^2 + 100^2} = 100.5\text{ e-}\end{aligned}\quad (7)$$

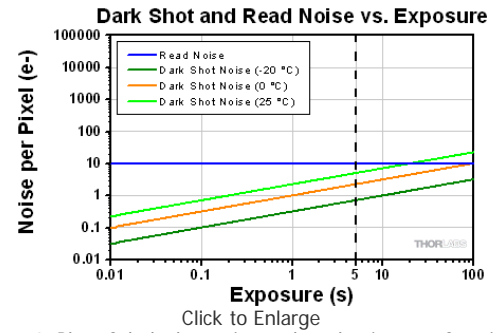

Figure 1: Plot of dark shot noise and read noise as a function of exposure for three sensor temperatures. This plot uses logarithmic scales for both axes. The dotted vertical line at 5 s indicates the values calculated as the example in the text.

The signal-to-noise ratio (SNR) is a useful figure of merit for image quality and is estimated as:

$$SNR = \frac{S}{\sigma_{eff}} \quad (8)$$

From Equation 7, the SNR values for the three sensor temperatures are:

$$SNR(25\text{ }^{\circ}\text{C}) = \frac{10000}{100.6} = 99.4 \quad (9)$$

$$SNR(0\text{ }^{\circ}\text{C}, -20\text{ }^{\circ}\text{C}) = \frac{10000}{100.5} = 99.5$$

As the example shows, there is a negligible benefit to using a cooled camera compared to a non-cooled camera operating at room temperature, and the photon shot noise is the dominant noise source in this example. In this case our standard package cameras should therefore work quite well.

However, if the light levels were lower such that a 100 second exposure was required to achieve 900 e- per pixel, then the shot noise would be 30 e-. The estimated dark shot noise would be 22.4 e- at 25 °C, while at -20 °C the dark shot noise would be 3.2 e-. The total effective noise would be

$$\sigma_{eff}(25\text{ }^{\circ}\text{C}) = \sqrt{22.4^2 + 10^2 + 30^2} = 38.7\text{ e-} \quad (10)$$

$$\sigma_{eff}(-20\text{ }^{\circ}\text{C}) = \sqrt{3.2^2 + 10^2 + 30^2} = 31.8\text{ e-}$$

From Equation 8, the SNR values are

$$SNR(25\text{ }^{\circ}\text{C}) = \frac{900}{38.7} = 23.3 \quad (11)$$

$$SNR(-20\text{ }^{\circ}\text{C}) = \frac{900}{31.8} = 28.3$$

In this example, the dark shot noise is a more significant contributor to the total noise for the 25 °C sensor than for the -25 °C sensor. Depending on the application's noise budget, a cooled camera may be beneficial.

Figure 2 shows plots of the different noise components, including dark shot noise at three sensor temperatures, as a function of exposure time for three photon fluxes. The plots show that dark shot noise is not a significant contributor to total noise except for low signal (and consequently long exposure) situations. While the photon flux levels used for the calculations are given in the figure, it is not necessary to know the exact photon flux level for your application. Figure 2 suggests a general metric based on exposure time that can be used to determine whether a cooled camera is required if the exposure time can be estimated, and these results are summarized in Table 2. If you find that your dominant source of noise is due to the read noise, then we recommend running the camera at a lower CCD pixel clock rate of 20 MHz, since that will offer a lower read noise.

Exposure	Camera Recommendation
<1 s	Standard Non-Cooled Camera Generally Sufficient
1 s to 5 s	Cooled Camera Could Be Helpful
5 s to 10 s	Cooled Camera Recommended
>10 s	Cooled Camera Usually Required

Table 2: From the results shown in Figure 1, these are the general "rule of thumb" recommendations related to cooling considerations based on the exposure requirements of an application. Please keep in mind that some applications are more sensitive to noise than others.

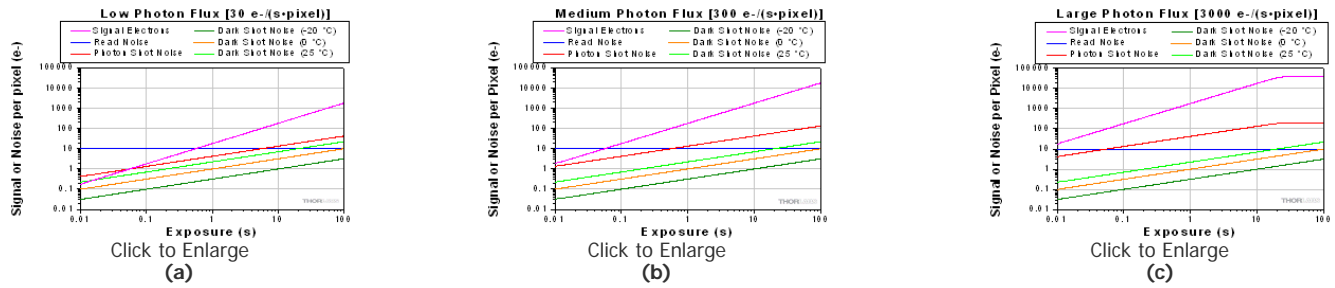
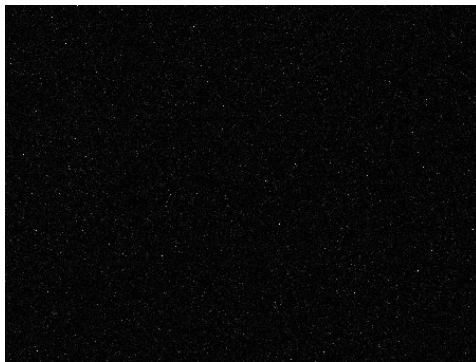

Figure 2: Noise from all sources as a function of exposure for three different photon fluxes: (a) low, (b) medium, and (c) high. In (c) the signal and photon shot noise saturate above approximately 20 seconds because the pixel becomes saturated at the corresponding incident photon levels. A quantum efficiency of 60% was used for the calculations. Note that these plots use logarithmic scales for both axes.

Other Considerations

Thermoelectric cooling should also be considered for long exposures even where the dark shot noise is not a significant contributor to total noise because cooling also helps to reduce the effects of hot pixels. Hot pixels cause a "star field" pattern that appears under long exposures. Figure 3 shows an example of this star field pattern for images taken using cameras with and without TEC cooling with an exposure of 10 seconds.



(a)

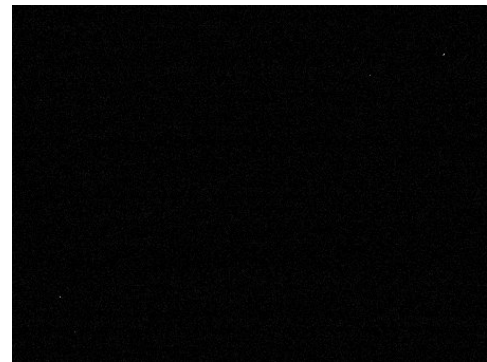

(b)

Figure 3: Images of the "star field" pattern that results from hot pixels using our (a) standard non-cooled camera and (b) our camera cooled to -20°C . Both images were taken with an exposure of 10 seconds and with a gain of 32 dB (to make the hot pixels more visible). Please note that in order to show the pattern the images displayed here were cropped from the full-resolution 16 bit images. The full size 16 bit images may be downloaded here and viewed with software such as ImageJ, which is a free download.

INTERFACE

Thorlabs offers three interface options across our scientific camera product line: USB 3.0, Gigabit Ethernet (GigE), and Camera Link. Once other camera decisions, such as field of view and frame rates, have been made, for many of our camera types it is necessary to choose one of these interfaces. It is important to confirm that the computer system meets or exceeds the recommended requirements listed to the right; otherwise, dropped frames may result, particularly when streaming camera images directly to storage media.

Definitions

- **Camera Frame Rate:** The number of images per second generated by the camera. It is a function of camera model and user-selected settings.
- **Effective Frame Rate:** The number of images per second received by the host computer's camera software. This depends on the limits of the selected interface hardware (chipset), CPU performance, and other devices and software competing for the host computer resources.
- **Maximum Bandwidth:** The maximum rate (in bits/second or bytes/second) at which data can be reliably transferred over the interface from the camera to the host PC. The maximum bandwidth is a specified performance benchmark of the interface, under the assumption that the host PC is capable of receiving and handling data at that rate. An interface with a higher maximum bandwidth will typically support higher camera frame rates, but the choice of interface does not

Recommended System Requirements	
Operating System	Windows [®] 7, 8.1, or 10 (64 bit)
Processor (CPU) ^a	≥3.0 GHz Intel Core i5, i7, or i8
Memory (RAM)	≥8 GB
Hard Drive	≥500 GB (SATA) Solid State Drive (SSD) ^b
Graphics Card	Dedicated ^c Adapter with ≥256 MB RAM
Power Supply	≥600 W
Motherboard	USB 3.0 (-USB) Cameras: Integrated Intel USB 3.0 Controller or One Unused PCIe x1 Slot (for Item # USB3-PCIE) Camera Link (-CL) Cameras: One Unused PCIe x4/x8/x16 Slot GigE (-GE) Cameras:

by itself increase the frame rate of the camera.

	One Unused PCIe x1 Slot
Connectivity	USB or Internet Connectivity for Driver Installation

USB 3.0

USB 3.0 is a standard interface available on most new PCs, which means that typically no additional hardware is required, and therefore these cameras are not sold with any computer hardware. For users with PCs that do not have a USB 3.0 port, a PCIe card is sold separately below. USB 3.0 supports a speed up to 320 MB/s and cable lengths up to 3 m. Support for multiple cameras is possible using multiple USB 3.0 ports on the PC or a USB 3.0 hub.

- Intel Core i3 processors and mobile versions of Intel processors may not satisfy the requirements.
- We recommend a solid state drive (SSD) for reliable streaming to disk during image sequence storage.
- On-board/integrated graphics solutions present on Intel Core i5 and i7 processors are also acceptable.



Gigabit Ethernet

GigE is ideal for situations requiring longer cable lengths, as well as for systems that require using multiple cameras with one computer. GigE supports a speed up to 100 MB/s and cable lengths up to 100 m. It also uses fairly inexpensive cables, but does require the use of a computer with a GigE card installed. Support for multiple cameras is easily achieved using a Gigabit Ethernet switch. However, the GigE card supplied with the camera is recognized as a public connection to the network; institutions with strict policies only allow registered devices and trusted connections. For any questions regarding using our GigE card at your institution, please contact your IT department.

Camera Link

Camera Link is ideal for applications requiring very high data transfer rates of up to 850 MB/s. However, the maximum cable length is 10 m. Camera Link requires the use of the supplied Camera Link card and cables for connecting to a computer. To operate our 4 and 8 megapixel cameras in quad-tap mode a second Camera Link connection is required.

Scientific Camera Interface Summary

Interface	USB 3.0	Gigabit Ethernet	Camera Link
Interface Image (Click to Enlarge)			
Maximum Cable Length	3 m	100 m	10 m
Maximum Bandwidth ^a	320 MB/s	100 MB/s	850 MB/s
Support for Multiple Cameras	Via Multiple USB 3.0 Ports or Hub	Via Switch Topology (Click for Details) ^b	No
Available Cameras	200 Frames per Second Scientific-Grade CCD Cameras 1.4 Megapixel Scientific-Grade CCD Cameras 4 Megapixel Scientific-Grade CCD Cameras 8 Megapixel Scientific-Grade CCD Cameras		

- Performance will vary depending on the exact PC configuration.
- Up to 4 cameras have been tested in the GigE switch topology.

TRIGGERING

Triggered Camera Operation

Our scientific cameras have three externally triggered operating modes: streaming overlapped exposure, asynchronous triggered acquisition, and bulb exposure driven by an externally generated trigger pulse. The trigger modes operate independently of the readout (e.g., 20 or 40 MHz; binning) settings as well as gain and offset. Figures 1 through 3 show the timing diagrams for these trigger modes, assuming an active low external TTL trigger.

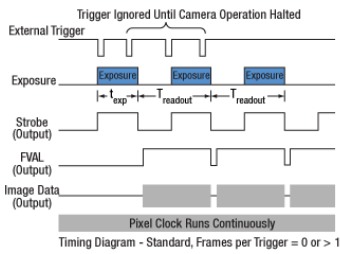

Click to Enlarge

Figure 1: Streaming overlapped exposure mode. When the external trigger goes low, the exposure begins, and continues for the software-selected exposure time, followed by the readout. This sequence then repeats at the set time interval. Subsequent external triggers are ignored until the camera operation is halted.

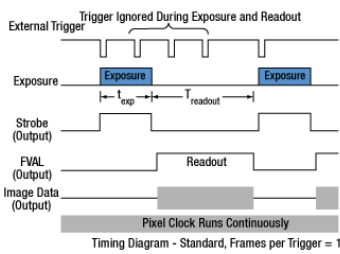

Click to Enlarge

Figure 2: Asynchronous triggered acquisition mode. When the external trigger signal goes low, an exposure begins for the preset time, and then the exposure is read out of the camera. During the readout time, the external trigger is ignored. Once a single readout is complete, the camera will begin the next exposure only when the external trigger signal goes low.

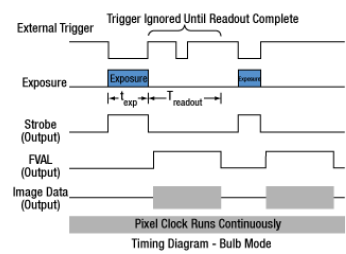

Click to Enlarge

Figure 3: Bulb exposure mode. The exposure begins when the external trigger signal goes low and ends when the external trigger signal goes high. Trigger signals during camera readout are ignored.

External triggering enables these cameras to be easily integrated into systems that require the camera to be synchronized to external events. The Strobe Output goes high to indicate exposure; the strobe signal may be used in designing a system to synchronize external devices to the camera exposure. External triggering requires a connection to the auxiliary port of the camera. We offer the 8050-CAB1 auxiliary cable as an optional accessory. Two options are provided to "break out" individual signals. The TSI-IOBOB provides SMA connectors for each individual signal. Alternately, the TSI-IOBOB2 also provides the SMA connectors with the added functionality of a shield for Arduino boards that allows control of other peripheral equipment. More details on these three optional accessories are provided below.

Trigger settings are adjusted using the ThorCam software. Figure 4 shows the Camera Settings window, with the trigger settings highlighted with red and blue squares. Settings can be adjusted as follows:

- **"HW Trigger" (Red Highlight) Set to "None"**: The camera will simply acquire the number of frames in the "Frames per Trigger" box when the capture button is pressed in ThorCam.
- **"HW Trigger" Set to "Standard"**: There are Two Possible Scenarios:
 - **"Frames per Trigger" (Blue Highlight) Set to Zero or >1**: The camera will operate in streaming overlapped exposure mode (Figure 1).
 - **"Frames per Trigger" Set to 1**: Then the camera will operate in asynchronous triggered acquisition mode (Figure 2).
- **"HW Trigger" Set to "Bulb (PDX) Mode"**: The camera will operate in bulb exposure mode, also known as Pulse Driven Exposure (PDX) mode (Figure 3).

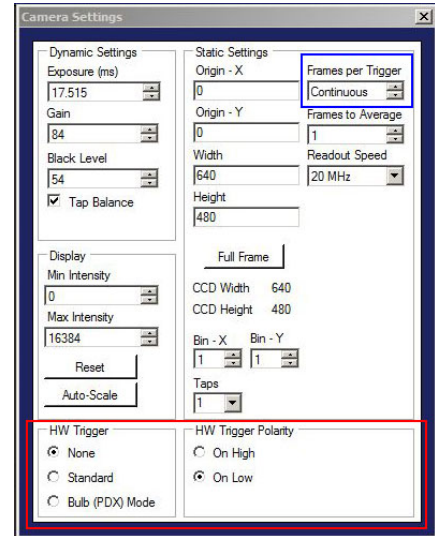

Figure 4: The ThorCam Camera Settings window. The red and blue highlighted regions indicate the trigger settings as described in the text.

In addition, the polarity of the trigger can be set to "On High" (exposure begins on the rising edge) or "On Low" (exposure begins on the falling edge) in the "HW Trigger Polarity" box (highlighted in red in Figure 4).

Example Camera Triggering Configuration using Scientific Camera Accessories

As an example of how camera triggering can be integrated into system control is shown in Figure 5. In the schematic, the camera is connected to the TSI-IOBOB2 break-out board / shield for Arduino using a 8050-CAB1 cable. The pins on the shield can be used to deliver signals to simultaneously control other peripheral devices, such as light sources, shutters, or motion control devices. Once the control program is written to the Arduino board, the USB connection to the host PC can be removed, allowing for a stand-alone system control platform; alternately, the USB connection can be left in place to allow for two-way communication between the Arduino and the PC. Configuring the external trigger mode is done using ThorCam as described above.

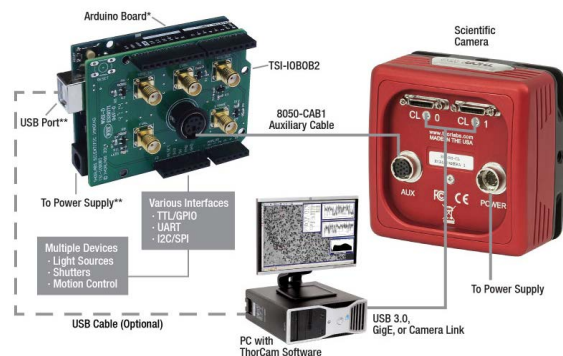

Figure 5: A schematic showing a system using the TSI-IOBOB2 to facilitate system integration and control.

Features

- Versions Available:
 - sCMOS: Quantalux[®] 2.1 MP Monochrome Sensor
 - CMOS: Kiralux[™] 2.3 MP, 5 MP, and 8.9 MP Monochrome, Color, or Polarization-Sensitive Sensors
 - CCD: Fast Frame Rate VGA, 1.4 MP, 4 MP, and 8 MP Monochrome or Color Sensors
 - 8 MP Monochrome CCD Model with Sensor Face Plate Removed
- High Quantum Efficiency
- Low Read Noise
- Software-Selectable Pixel Clock Speed
- Region-of-Interest (ROI) and Binning Modes
- 32- and 64-Bit Windows[®] 7 or 10 Support
- Asynchronous, Triggered, and Bulb Exposure Modes
- SDK and Programming Interfaces Provide Support for:
 - C, C++, C#, Python, and Visual Basic .NET APIs
 - LabVIEW, MATLAB, and μ Manager Third-Party Software



Click to Enlarge
Camera Housings of Our Compact Scientific and Scientific CCD Cameras

Our scientific cameras utilize high quantum efficiency, low noise sensors, which make them ideal for multispectral imaging, fluorescence microscopy, and other high-performance imaging techniques. Our Compact Scientific Cameras, including the Quantalux[®] sCMOS camera, are housed in compact, passively cooled housings. Our Scientific CCD cameras are available with TE-cooled and non-cooled housings. See below for more details on the camera packages offered.

*Only intensity images can be taken when controlling the Kiralux[™] Polarization-Sensitive Compact Scientific Camera using μ Manager; the ThorCam software is required to produce images with polarization information.

Compact Scientific Cameras				
Camera Type	Quantalux [®] 2.1 MP sCMOS	Kiralux [™] 2.3 MP CMOS	Kiralux [™] 5 MP CMOS	Kiralux [™] 8.9 MP CMOS
Item #	Monochrome: CS2100M-USB	Monochrome: CS235MU Color: CS235CU	Monochrome: CS505MU Color: CS505CU Polarization: CS505MUP	Monochrome: CS895MU Color: CS895CU
Electronic Shutter	Rolling Shutter ^a	Global Shutter		
Sensor Type	sCMOS	CMOS		
Number of Pixels (H x V)	1920 x 1080	1920 x 1200	2448 x 2048	4096 x 2160
Pixel Size	5.04 μ m x 5.04 μ m	5.86 μ m x 5.86 μ m	3.45 μ m x 3.45 μ m	
Optical Format	2/3" (11 mm Diagonal)	1/1.2" (13.4 mm Diagonal)	2/3" (11 mm Diagonal)	1" (16 mm Diagonal)
Peak Quantum Efficiency (Click for Plot)	Monochrome: 61% (at 600 nm)	Monochrome: 78% (at 500 nm) Color: Click for Plot	Monochrome & Polarization: 72% (Over 525 to 580 nm) Color: Click for Plot	Monochrome: 72% (Over 525 to 580 nm) Color: Click for Plot
Max Frame Rate (Full Sensor)	50 fps	39.7 fps	35 fps	20.8 fps
Read Noise	<1 e ⁻ Median, <1.5 e ⁻ RMS	<7.0 e ⁻ RMS	<2.5 e ⁻ RMS	
Digital Output (Max)	16 Bit	12 Bit		
Available Fanless Cooling	Passive Thermal Management			
PC Interface	USB 3.0			
Housing Dimensions (Click to Enlarge)	Compact Scientific Camera			
Typical Applications	Fluorescence Microscopy VIS/NIR Imaging Quantum Dots Autofluorescence Materials Inspection Multispectral Imaging Fluorescence <i>In Situ</i> Hybridization (FISH)	Fluorescence Microscopy Immunohistochemistry (IHC) Machine Vision Inspection General Purpose Imaging	<u>Monochrome & Color Models:</u> Fluorescence Microscopy Immunohistochemistry (IHC) Machine Vision & Inspection <u>Polarization Model:</u> Machine Vision & Inspection Transparent Material Detection	Fluorescence Microscopy Immunohistochemistry (IHC) Large FOV Slide Imaging Machine Vision Inspection

- Rolling Shutter with Equal Exposure Pulse (EEP) Mode for Synchronizing the Camera and Light Sources for Even Illumination

Scientific CCD Cameras						
Camera Type	Fast Frame Rate VGA CCD		1.4 MP CCD	4 MP CCD	8 MP CCD	
Item # Prefix	Monochrome: 340M	UV-Enhanced Monochrome: 340UV	Monochrome: 1501M Color: 1501C	Monochrome: 4070M Color: 4070C	Monochrome: 8051M Color: 8051C	No Sensor Face Plate Monochrome: S805MU
Electronic Shutter	Global Shutter					
Sensor Type	CCD					
Number of Pixels (H x V)	640 x 480		1392 x 1040	2048 x 2048	3296 x 2472	
Pixel Size	7.4 μm x 7.4 μm		6.45 μm x 6.45 μm	7.4 μm x 7.4 μm	5.5 μm x 5.5 μm	
Optical Format	1/3" (5.92 mm Diagonal)		2/3" (11 mm Diagonal)	4/3" (21.4 mm Diagonal)	4/3" (22 mm Diagonal)	
Peak QE (Click for Plot)	55% (at 500 nm)	10% (at 485 nm)	Monochrome: 60% (at 500 nm) Color: Click for Plot	Monochrome: 52% (at 500 nm) Color: Click for Plot	Monochrome: 51% (at 460 nm) Color: Click for Plot	51% (at 460 nm)
Max Frame Rate (Full Sensor)	200.7 fps (at 40 MHz Dual-Tap Readout)		23 fps (at 40 MHz Single-Tap Readout)	25.8 fps (at 40 MHz Quad-Tap Readout) ^a	17.1 fps (at 40 MHz Quad-Tap Readout) ^b	17.1 fps (at 40 MHz Quad-Tap Readout)
Read Noise	<15 e ⁻ at 20 MHz		<7 e ⁻ at 20 MHz (Standard Models) <6 e ⁻ at 20 MHz (-TE Models)	<12 e ⁻ at 20 MHz	<10 e ⁻ at 20 MHz	
Digital Output (Max)	14 Bit ^c		14 Bit	14 Bit ^c		14 Bit
Available Fanless Cooling	Passive Thermal Management		-20 °C at 20 °C Ambient Temperature		-10 °C at 20 °C Ambient	Passive Thermal Management
Available PC Interfaces	USB 3.0, Gigabit Ethernet, or Camera Link					USB 3.0
Housing Dimensions (Click to Enlarge)	Non-Cooled Scientific CCD Camera		Cooled Scientific CCD Camera Non-Cooled Scientific CCD Camera			No Face Plate Scientific CCD Camera
Typical Applications	Ca ⁺⁺ Ion Imaging Particle Tracking Flow Cytometry SEM/EBSD UV Inspection		Fluorescence Microscopy VIS/NIR Imaging Quantum Dots Multispectral Imaging Immunohistochemistry Retinal Imaging Fluorescence <i>In Situ</i> Hybridization (FISH)	Fluorescence Microscopy Transmitted Light Microscopy Whole-Slide Microscopy Electron Microscopy (TEM/SEM) Inspection Material Sciences	Fluorescence Microscopy Whole-Slide Microscopy Large FOV Slide Imaging Histopathology Inspection Multispectral Imaging Immunohistochemistry	Beam Profiling & Characterization Interferometry VCSEL Inspection Quantitative Phase-Contrast Microscopy Ptychography Digital Holographic Microscopy

- a. Limited to 13 fps at 40 MHz dual-tap readout for Gigabit Ethernet cameras; quad-tap readout is unavailable for Gigabit Ethernet cameras.
- b. Limited to 8.5 fps at 40 MHz dual-tap readout for Gigabit Ethernet cameras; quad-tap readout is unavailable for Gigabit Ethernet cameras.
- c. Gigabit Ethernet cameras operating in dual-tap readout mode are limited to 12-bit digital output.



The Camera Link versions of these cameras (Item #s 1501M-CL and 1501M-CL-TE) will be retired without replacement when stock is depleted. If you require either of these parts for line production,

please contact our OEM Team.

Part Number	Description	Price	Availability
1501M-USB	1.4 Megapixel Monochrome Scientific CCD Camera, Standard Package, USB 3.0 Interface	\$6,047.13	Today
1501M-USB-TE	1.4 Megapixel Monochrome Scientific CCD Camera, Hermetically Sealed Cooled Package, USB 3.0 Interface	\$9,229.83	Today
1501M-GE	1.4 Megapixel Monochrome Scientific CCD Camera, Standard Package, GigE Interface	\$6,047.13	Today
1501M-GE-TE	1.4 Megapixel Monochrome Scientific CCD Camera, Hermetically Sealed Cooled Package, GigE Interface	\$9,229.83	Today
1501M-CL	1.4 Megapixel Monochrome Scientific CCD Camera, Standard Package, Camera Link Interface	\$8,062.84	Today
1501M-CL-TE	1.4 Megapixel Monochrome Scientific CCD Camera, Hermetically Sealed Cooled Package, Camera Link Interface	\$11,245.54	Lead Time

À

Color 1.4 Megapixel Scientific CCD Cameras



The Camera Link versions of these cameras (Item #s 1501C-CL and 1501C-CL-TE) will be retired without replacement when stock is depleted. If you require either of these parts for line production,

please contact our OEM Team.

Part Number	Description	Price	Availability
1501C-USB	1.4 Megapixel Color Scientific CCD Camera, Standard Package, USB 3.0 Interface	\$6,047.13	Today
1501C-USB-TE	1.4 Megapixel Color Scientific CCD Camera, Hermetically Sealed Cooled Package, USB 3.0 Interface	\$9,229.83	Lead Time
1501C-GE	1.4 Megapixel Color Scientific CCD Camera, Standard Package, GigE Interface	\$6,047.13	Today
1501C-GE-TE	1.4 Megapixel Color Scientific CCD Camera, Hermetically Sealed Cooled Package, GigE Interface	\$9,335.92	Lead Time
1501C-CL	1.4 Megapixel Color Scientific CCD Camera, Standard Package, Camera Link Interface	\$8,168.93	Today
1501C-CL-TE	1.4 Megapixel Color Scientific CCD Camera, Hermetically Sealed Cooled Package, Camera Link Interface	\$11,351.63	Lead Time

À

Scientific Camera Optional Accessories



Click to Enlarge

These optional accessories allow for easy use of the auxiliary port of our scientific CCD, CMOS, and Quantalux™ sCMOS cameras. These items should be considered when it is necessary to externally trigger the camera, to monitor camera performance with an oscilloscope, or for simultaneous control of the camera with other instruments.



Click to Enlarge

For our USB 3.0 cameras, we also offer a PCIe USB 3.0 card and extra cables for facilitating the connection to the computer.

Auxiliary I/O Cable (8050-CAB1)

The 8050-CAB1 is a 10' (3 m) long cable that mates with the auxiliary connector on our scientific cameras* and provides the ability to externally trigger the camera as well as monitor status output signals. One end of the cable features a male 12-pin connector for connecting to the camera, while the other end has a male 6-pin Mini Din connector for connecting to external devices. This cable is ideal for use with our interconnect break-out boards described below. For information on the pin layout, please see the *Pin Diagrams* tab above.



Click for Details
A schematic showing a TSI-IOBOB2 connected to an Arduino in a custom camera system.

Interconnect Break-Out Board (TSI-IOBOB)

The TSI-IOBOB is designed to "break out" the 6-pin Mini Din connector found on our scientific camera auxiliary cables into five SMA connectors. The SMA connectors can then be connected using SMA cables to other devices to provide a trigger input to the camera or to monitor camera performance. The pin configurations are listed on the *Pin Diagrams* tab above.

Interconnect Break-Out Board / Shield for Arduino (TSI-IOBOB2)

The TSI-IOBOB2 offers the same breakout functionality of the camera signals as the TSI-IOBOB. Additionally, it functions as a shield for Arduino, by placing the TSI-IOBOB2 shield on an Arduino board supporting the Arduino Uno Rev. 3 form factor. While the camera inputs and outputs are 5 V TTL, the TSI-IOBOB2 features bi-directional logic level converters to enable compatibility with Arduino boards operating on either 5 V or 3.3 V logic. Sample programs for controlling the

scientific camera are available for download from our software page, and are also described in the manual (found by clicking on the red Docs icon below). For more information on Arduino, or for information on purchasing an Arduino board, please see www.arduino.cc.

The image to the right shows a schematic of a configuration with the TSI-IOBOB2 with an Arduino board integrated into a camera imaging system. The camera is connected to the break-out board using a 8050-CAB1 cable that must be purchased separately. The pins on the shield can be used to deliver signals to simultaneously control other peripheral devices, such as light sources, shutters, or motion control devices. Once the control program is written to the Arduino board, the USB connection to the host PC can be removed, allowing for a stand-alone system control platform; alternately, the USB connection can be left in place to allow for two-way communication between the Arduino and the PC. The compact size of 2.70" x 2.10" (68.6 mm x 53.3 mm) also aids in keeping systems based on the TSI-IOBOB2 compact.

USB 3.0 Camera Accessories (USB3-MBA-118 and USB3-PCIE)

We also offer a USB 3.0 A to Micro B cable for connecting our cameras to a PC (please note that one cable is included with each USB 3.0 camera). The cable measures 118" long and features screws on either side of the Micro B connector that mate with tapped holes on the camera for securing the USB cable to the camera housing.

A USB 3.0 PCIe card is also provided for computers that do not offer USB 3.0 connectors with an integrated Intel USB 3.0 controller. However, since most newer computers offer several USB 3.0 connections, a USB 3.0 PCIe card is not included with the purchase of a USB 3.0 camera. The card has two type A USB 3.0 ports.

*The 8050-CAB1 is not compatible with our former-generation 1500M series cameras.

Part Number	Description	Price	Availability
8050-CAB1	I/O Cable for Scientific CCD and Compact Scientific Cameras	\$76.49	Today
TSI-IOBOB	I/O Break-Out Board for Scientific CCD and Compact Scientific Cameras	\$68.96	Today
TSI-IOBOB2	Customer Inspired! I/O Break-Out Board for Scientific CCD and Compact Scientific Cameras with Shield for Arduino (Arduino Board not Included)	\$99.06	Today
USB3-MBA-118	USB 3.0 A to Micro B Cable, Length: 118" (3 m)	\$38.69	5-8 Days
USB3-PCIE	USB 3.0 PCI Express Expansion Card	\$66.28	Today

À

Optional Accessories for Former-Generation 1500M Series Cameras

The 1500-CAB1 is a 10' (3 m) long cable that mates with the auxiliary connector on our former-generation 1500M Series 1.4 megapixel CCD cameras and provides the ability to externally trigger the camera as well as monitor status output signals. Both ends of the cable feature a male 6-pin Mini Din connector. This cable is ideal for use with our interconnect break-out boards described above. For information on the pin layout, please see the diagram and table below.

This cable is only compatible with our former-generation item #'s 1500M-GE, 1500M-GE-TE, 1500M-CL, and 1500M-CL-TE.

Pin Number ^a	Signal	Description
1	LVAL (Output)	Refers to "Line Valid." It is an active-high TTL signal and is asserted during the valid period on each line. It returns low during the inter-line period between each line and during the inter-frame period between each frame.
2	CC1_OUT (Output)	An active-low TTL signal that is the buffered version of the Camera Link CC1 signal. The CC1 signal is driven from the host and is one of the software control signals for the camera. CC1_OUT allows triggering of other devices.
3	TRIGGER_IN (Input)	A TTL input used to trigger exposures on the transition from the high to low state. (Both Ends of 1500-CAB1)
4	GND	The electrical ground for the camera signals.
5	FVAL (Output)	Refers to "Frame Valid." It is a TTL output that is high during active readout lines and returns low between frames.
6	STROBE (Output)	A TTL output that is high during the actual sensor exposure time when in continuous, overlapped exposure mode. It is typically used to synchronize an external flash lamp or other device with the camera.

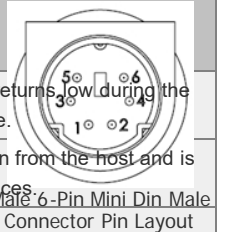

- a. The same pin numbers are used on the camera and the TSI-IOBOB and TSI-IOBOB2 break-out boards.

Part Number	Description	Price	Availability
1500-CAB1	I/O Cable with Ferrite Core for Former-Generation 1500M Series Scientific CCD Cameras	\$32.78	Today

