

CHAPTERS

Laser Scanning
MicroscopyMicroscopy
ComponentsOCT Imaging
Systems

OCT Components

Adaptive Optics

SECTIONS

Overview

Adaptive Optics Kit

Deformable Mirrors

Wavefront Sensors

2P-AO

Adaptive Optics Kits (Page 1 of 6)

NEW
products

Overview

Thorlabs' Adaptive Optics (AO) Kits are designed to enable easy integration of wavefront correction into research imaging systems. Each kit includes a MEMS-based deformable mirror manufactured by Boston Micromachines Corporation, a Thorlabs Shack-Hartmann wavefront sensor, all necessary imaging optics and mounting hardware, application software, a full-features software development kit (SDK), and Application Programming Interface (API) documentation for integration of adaptive optics into end-user software. The kit ships as three pre-aligned optomechanical sections that only need to be arranged on a user-supplied breadboard, providing a near out-of-the-box solution for real-time wavefront analysis and correction.

Thorlabs now offers eight variations of AO Kits. Choose from a gold- or aluminum-coated deformable mirror with 140 or 32 actuators and a CCD- or CMOS-based Shack-Hartmann wavefront sensor. Details on all eight AO Kit options are outlined below.

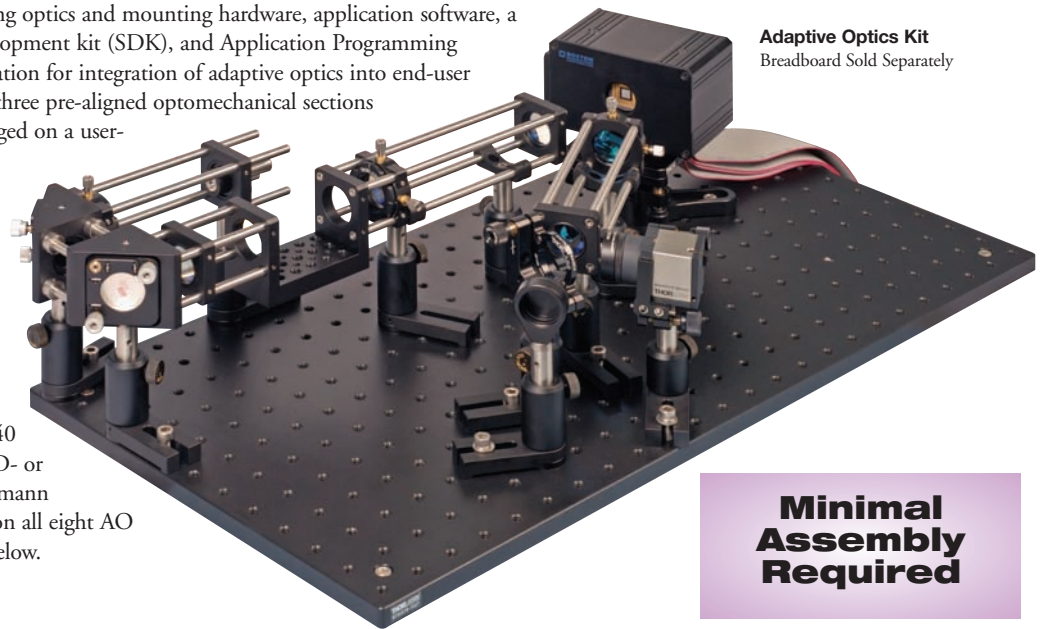
Adaptive Optics Kit
Breadboard Sold SeparatelyMinimal
Assembly
Required

Features

- Complete Kit for Wavefront Measurement and Control
- Includes MEMS-Based Deformable Mirror, Shack Hartmann Wavefront Sensor, and All Required Optics and Mechanics (Partially Pre-Assembled)
- Control Software for Closed-Loop Operation
- Software Development Kit Included
- 2:1 Sampling of Spots-to-Actuators Eliminates "Waffle" Error
- MEMS DM Structure Offers a Robust Design and Optimal Performance
- 3.5 μm Stroke with 14-Bit Control and Zero-Hysteresis, Provides Higher Repeatable Precision Wavefront Control than Other DM Technologies
- Operating Wavelength
 - 400 – 1100 nm (Aluminum-Coated DM)
 - 600 – 1100 nm (Gold-Coated DM)
- Options
 - CCD- or CMOS-Based Wavefront Sensor
 - 140 (12 x 12 Array) or 32 (6 x 6 Array) Actuator Deformable Mirror
 - Gold- or Aluminum-Coated Deformable Mirror

Kit Specifications: Order & Pricing Information on Page 1795

KIT ITEM #	AOK2-UM01	AOK2-UP01	AOK4-UM01	AOK4-UP01	AOK1-UM01	AOK1-UP01	AOK3-UM01	AOK3-UP01
Deformable Mirror Item #	DM32-35-UM01	DM32-35-UP01	DM32-35-UM01	DM32-35-UP01	DM140-35-UM01	DM140-35-UP01	DM140-35-UM01	DM140-35-UP01
Mirror Coating	Gold	Aluminum	Gold	Aluminum	Gold	Aluminum	Gold	Aluminum
Actuator Array	6 x 6 (32 Actuators)*				12 x 12 (140 Actuators)*			
Actuator Stroke (Max)	3.5 μm (5.5 μm Available Upon Request)				3.5 μm (5.5 μm Available Upon Request)			
Actuator Pitch	400 μm				400 μm			
Clear Aperture	2.0 mm x 2.0 mm				4.4 mm x 4.4 mm			
Average Step Size	<1 nm				<1 nm			
Wavefront Sensor	WFS150-5C		WFS10-5C		WFS150-5C		WFS10-5C	
Sensor Type	CCD		CMOS		CCD		CMOS	
Frame Rate (Max)	15 Hz		450 Hz		15 Hz		450 Hz	
Wavelength Range	300 – 1100 nm							
Camera Resolution (Max)	1280 x 1024 Pixels (Selectable)		640 x 480 Pixels (Selectable)		1280 x 1024 Pixels (Selectable)		640 x 480 Pixels (Selectable)	
Pixel Size	4.65 x 4.65 μm		9.9 x 9.9 μm		4.65 x 4.65 μm		9.9 x 9.9 μm	
Number of Lenslets (Max)	39 x 31 (Selectable)		41 x 29 (Selectable)		39 x 31 (Selectable)		41 x 29 (Selectable)	
Wavefront Dynamic Range**	>100 λ				>100 λ			
Wavefront Sensitivity**	$\lambda/50$ rms		$\lambda/30$ rms		$\lambda/50$ rms		$\lambda/30$ rms	
Exposure Range	79 μs - 65 ms		33 μs - 500 ms		79 μs - 65 ms		33 μs - 500 ms	

*The 4 corner actuators are inactive. **@ 633 nm

Adaptive Optics Kits (Page 2 of 6)



Deformable Mirror Head

Deformable Mirrors

Thorlabs offers four Deformable Mirror (DM) options for the Adaptive Optics Kits. Two options incorporate Boston Micromachines Corporation's (BMC's) 140 actuator deformable mirror (Multi-DM) while the other two options incorporate BMC's 32 actuator deformable mirror (Mini-DM). Both the Multi-DM and Mini-DM are available with either an aluminum- or gold-coated mirror.

All DM's contain a protective 6 wedge in front of the mirror with a broadband AR coating for the 400 – 1100 nm range (custom AR coatings available upon request). When combined with a Shack-Hartmann wavefront sensor, these kits are designed for use in either the 600 – 1100 nm (kits with a gold-coated mirror) or the 400 – 1100 nm (kits with an aluminum-coated mirror) range.

Deformable Mirror Composition

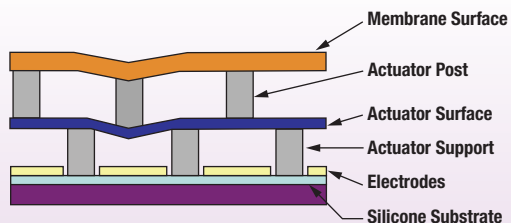

Micro-electro-mechanical (MEMS) deformable mirrors are widely used for wavefront shaping applications mainly due to their versatility and ability to produce sub-nanometer, high-resolution wavefront correction. Unlike piezoelectric mirrors, the electrostatic actuation used with these DMs ensures deformation without hysteresis.

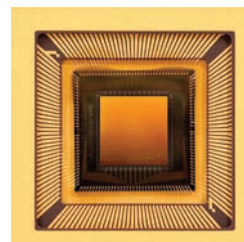

Close up of Deformable Mirror

Deformable Mirror Coating Curves

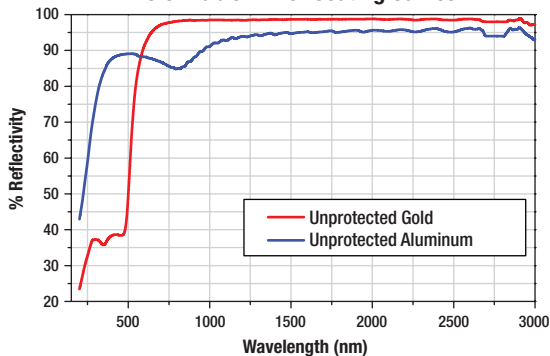

Contact Tech Support to Inquire about Custom AR Coating Options

Reflectivity vs. Wavelength of AR Coating (Normal Incidence)

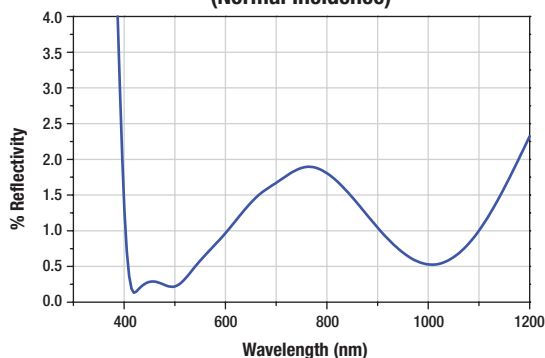

Deformable Mirror Specifications: Order & Pricing Information on Page 1797

KIT ITEM #	AOK2-UM01	AOK2-UP01	AOK4-UM01	AOK4-UP01	AOK1-UM01	AOK1-UP01	AOK3-UM01	AOK3-UP01
Deformable Mirror Item #	DM32-35-UM01	DM32-35-UP01	DM32-35-UM01	DM32-35-UP01	DM140-35-UM01	DM140-35-UP01	DM140-35-UM01	DM140-35-UP01
Deformable Mirror	Mini-DM				Multi-DM			
Mirror Coating	Gold	Aluminum	Gold	Aluminum	Gold	Aluminum	Gold	Aluminum
Actuator Array	6 x 6				12 x 12			
Actuator Stroke (Max)	3.5 μm (5.5 μm Available Upon Request)							
Actuator Pitch	400 μm							
Clear Aperture	2.0 mm x 2.0 mm				4.4 mm x 4.4 mm			
Mirror Coating	600 – 1100 nm	400 – 1100 nm	600 – 1100 nm	400 – 1100 nm	600 – 1100 nm	400 – 1100 nm	600 – 1100 nm	400 – 1100 nm
Frame Rate with Feedback (Max)	8 kHz (34 kHz Burst)							
Average Step Size	<1 nm							
Resolution	14 Bit							
Head Dimensions	4.5" x 2.95" x 2.8" (114.3 mm x 74.9 mm x 71.1 mm)							
Driver Dimensions	4.0" x 5.25" x 1.25" (102 mm x 133 mm x 32 mm)				9.0" x 7.0" x 2.5" (229 mm x 178 mm x 64 mm)			
Computer Interface	USB2.0							

CHAPTERS

Laser Scanning Microscopy

Microscopy Components

OCT Imaging Systems

OCT Components

Adaptive Optics

SECTIONS

Overview

Adaptive Optics Kit

Deformable Mirrors

Wavefront Sensors

2P-AO

Adaptive Optics Kits (Page 3 of 6)

WFS150-5C



Shack-Hartmann Wavefront Sensors

The role of the wavefront sensor in an adaptive optics system is to measure the wavefront deviations from a reference wavefront. Thorlabs' Adaptive Optics Kits are available with either the WFS150-5C high-sensitivity or WFS10-5C high-speed wavefront sensor. All of our wavefront sensors use a microlens array with an AR coating for the 300 – 1100 nm wavelength range.

The lenslet array divides an incoming beam into many smaller beams, each of which is imaged onto the camera sensor, which is placed at the focal plane of the lenslet array. If a uniform plane wave is incident on the Shack-Hartmann wavefront sensor (see Figure 1), a focused spot is formed along the optical axis of each lenslet, yielding a regularly spaced grid of spots in the focal plane. However, if a distorted wavefront (i.e., any non-flat wavefront) is incident, the focal spots will be displaced from the optical axis of each lenslet. The amount of shift of each spot's centroid is proportional to the local slope (i.e., tilt) of the wavefront at the location of that lenslet. The wavefront phase can then be reconstructed from the spot displacement information obtained.

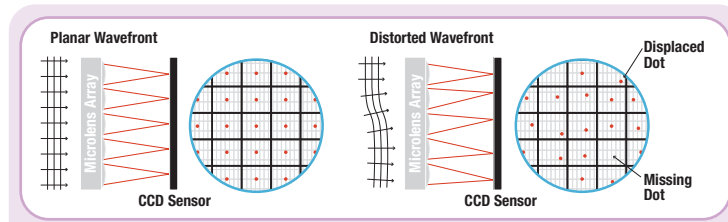

Figure 1. When a planar wavefront is incident on the Shack-Hartmann wavefront sensor's microlens array, the light imaged on the sensor will display a regularly spaced grid of spots. If, however, the wavefront is aberrated, individual spots will be displaced from the optical axis of each lenslet; if the displacement is large enough, the image spot may even appear to be missing. This information is used to calculate the shape of the wavefront that was incident on the microlens array.

The AOK1-UM01, AOK1-UP01, AOK2-UM01, and AOK2-UP01 utilize the high-sensitivity, high-resolution WFS150-5C wavefront sensor, which operates up to 15 frames per second. For high-speed applications, we have developed the AOK3-UM01, AOK3-UP01, AOK4-UM01, and AOK4-UP01 Adaptive Optics Kits, which utilize our WFS10-5C high-speed wavefront sensor. The WFS10-5C is able to operate up to 450 frames per second.

With Thorlabs' Shack-Hartmann wavefront sensors, users can measure the wavefronts of laser sources, characterize the wavefront aberrations caused by optical components, and provide real-time feedback for the control of the deformable mirror.

ITEM #	AOK2-UM01	AOK2-UP01	AOK4-UM01	AOK4-UP01	AOK1-UM01	AOK1-UP01	AOK3-UM01	AOK3-UP01
Deformable Mirror	Mini-DM (32 Actuators)				Multi-DM (140 Actuators)			
Wavefront Sensor	WFS150-5C		WFS10-5C		WFS150-5C		WFS10-5C	
Sensor Type	CCD		CMOS		CCD		CMOS	
Frame Rate (Max)	15 Hz		450 Hz		15 Hz		450 Hz	
Wavelength Range	300 – 1100 nm							
Camera Resolution (Max)	1280 x 1024 Pixels (Selectable)		640 x 480 Pixels (Selectable)		1280 x 1024 Pixels (Selectable)		640 x 480 Pixels (Selectable)	
Pixel Size	4.65 μm x 4.65 μm		9.9 μm x 9.9 μm		4.65 μm x 4.65 μm		9.9 μm x 9.9 μm	
Number of Lenslets (Max)	39 x 31 (Selectable)		41 x 29 (Selectable)		39 x 31 (Selectable)		41 x 29 (Selectable)	
Lenslet Pitch	150 μm							
Lenslet Diameter	146 μm							
Effective Focal Length	3.7 μm							
Wavefront Sensitivity @ 633 nm	λ/50 rms		λ/30 rms		λ/50 rms		λ/30 rms	

The Benefits of Adaptive Optics

The deformable mirror's impressive wavefront correction abilities are demonstrated in these images. An incoming distorted wavefront will retain its aberrations upon reflection from a flat mirror (a); in contrast, a DM can modify its surface profile to compensate for aberrations so that the distorted incident wavefront is unaberrated upon reflection (b). Consequently, when using a flat mirror to image an air force target, the image is completely blurred, making it impossible to distinguish any structure (c). However, if a DM is used instead, the smallest lines, which are only separated by 2 μm, are now discernable (d).

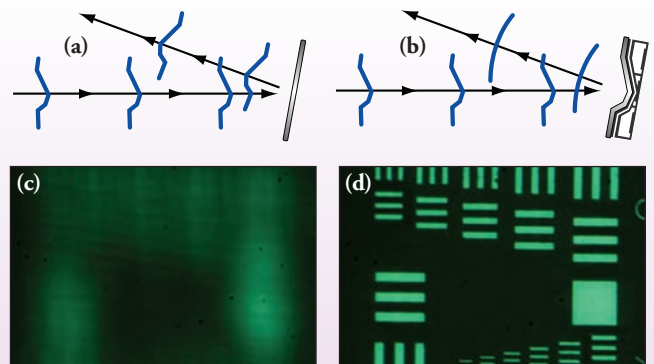

Adaptive Optics Kits (Page 4 of 6)

Deformable Mirror Control

- Real-Time Representation of the Deformable Mirror Actuator Displacements (Based on Voltages Applied to the Mirror)
- Spreadsheet-Like Numerical Interface Provides User-Input of Actuator Deflections
- Save/Recall Mirror Surface Maps

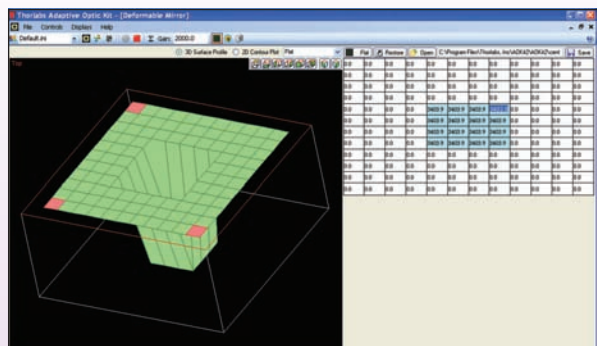

The deformable mirror control shows a graphical plot of the DM surface shape as well as a spreadsheet-like numerical interface that allows the user to input actuator deflections (in nanometers). The actuator deflection values may be changed individually or in selected groups. The actual shape of the DM will differ slightly due to a small influence of adjacent actuators.

Specific mirror shapes can be loaded and saved from this window, allowing the creation of a library of unique and specialized mirror shapes that can be later recalled at the click of a button.

Shack-Hartmann Control

- Four Tab Displays
 - Wavefront Sensor Spot Field Measured Directly from the Sensor
 - Wavefront Plot (See Example at Right)
 - Contour Wavefront Plot
 - Measured Zernike Coefficients
- Wavefront Plot is Scalable / Rotatable
- Easily Access Wavefront Sensor and Display Control Settings in Each Tab Display
- Display Measured, Reference, or Difference Wavefront Plots
- Min/Max Threshold Eliminate 'Flickering' Active/Inactive WFS Spots
- User-Controllable Spot Centroid and Reference Spot Indicators (See Example to the Right)

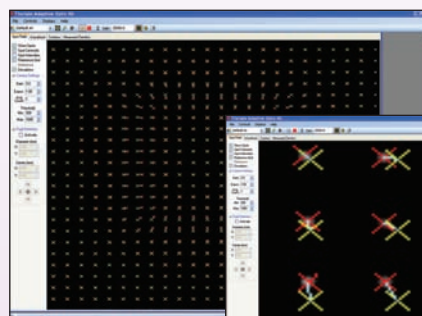
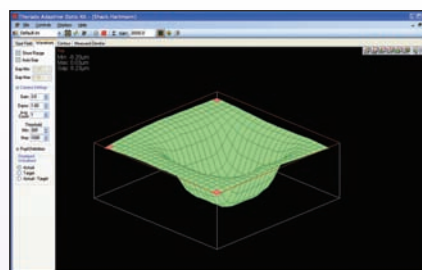

There is a user-adjustable hysteresis setting for the inclusion or exclusion of spots in the wavefront measurements. This setting is primarily used to filter out spots for which the intensity fluctuation has fallen below a low-end cut-off threshold. Once a spot is excluded, it will not be reintroduced into the wavefront measurement until its intensity exceeds a high-end threshold.

In the spot field window (bottom right), the camera's exposure time and gain can be controlled. A pupil control allows the user to analyze the wavefront data within a user-defined circular pupil. The camera image of the spots (white spots in inset), spot centroid locations (red X's), reference locations (yellow X's), deviations (white lines between red and yellow X's), and intensity levels may easily be displayed in the spot field window.

In addition to the camera controls mentioned above, when viewing the wavefront, the user has the option to display the measured wavefront, target (reference) wavefront, or the difference between these two wavefronts. There are predefined view angles for the wavefront plot, or it can be continuously adjusted by the user.

Zernike Wavefront Generator Control

- User-Controllable Reference Wavefront
- User-Defined Reference Using First 36 Zernike Terms
- User-Captured Reference Wavefront
- 3D Surface Plot or 2D Contour Plot Display

The Wavefront Generator control enables the user to create a reference wavefront by combining the first 36 Zernike polynomials in the spreadsheet-like grid. A graphical display of the created wavefront, along with the minimum, maximum, and peak-to-peak wavefront deviations are provided.

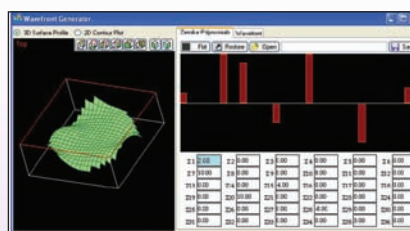

The wavefront generator control window also allows the user to capture the current measured wavefront and set it as the reference wavefront. Reference wavefronts can be saved and later recalled by the user.

▼ CHAPTERS

Laser Scanning
MicroscopyMicroscopy
ComponentsOCT Imaging
Systems

OCT Components

Adaptive Optics

▼ SECTIONS

Overview

Adaptive Optics Kit

Deformable Mirrors

Wavefront Sensors

2P-AO

Adaptive Optics Kits (Page 5 of 6)

Software Development Kit

The Adaptive Optics Kit includes a Software Development Kit (SDK) in the form of a flexible, cross-platform-compatible Dynamic Link Library (DLL) ideal for user-authored applications. The kit additionally includes full-featured Windows application software with easy-to-use Graphical User Interface (GUI) for full system control right out of the box. The SDK is designed to be a conduit for easy integration of AO instrumentation, control, and arithmetic functions into a user system. The application software provides immediate interaction with the AO Kit Deformable Mirror and Shack-Hartmann Wavefront Sensor. This software is ideal for research, development, and educational applications. Additionally, the demo software provides pop-up tooltips containing detailed information pertaining to specific function calls dispatched by the associated GUI control.

SDK Memory Management

A unique aspect to the SDK is its versatile memory structure. We provide an SDK that is compatible with a broad range of programming environments, including C-based languages, Visual Basic, LabVIEW, and any other language capable of interfacing with standard DLLs. These languages allocate data memory using different methods. In order to maximize performance and cross-platform compatibility, the SDK employs a flexible memory structure that allows it to transparently use either its own or user software-allocated data space.

Features

- Dynamic Link Library (DLL) Compatible with C/C++, VB, and LabVIEW™
- Direct DM and WFS Control Functions
- All Data Structures and Data Processing Algorithms Available for User-Authored Applications
- Calibration, Dynamic Reference Wavefront Creation, and Open- and Closed-Loop Functionalities
- Example Code Included

DLL Features

- Versatile Memory Structure
- Comprehensive DLL Application Library
 - Read from and Control the Wavefront Sensor
 - Drive the Deformable Mirror
 - Determine Wavefront Deviations
- Control Multiple Wavefront Sensors and Deformable Mirrors Simultaneously
- Expandable to Other Commercially Available Adaptive Optics Kits

Application Software

For immediate out-of-the-box operation, the AO Kit comes with a fully functional application that has been built from the SDK DLL library of functions. This demo software is capable of minimizing wavefront aberrations by analyzing the signals from the Shack-Hartmann wavefront sensor and then deterministically calculating the deformable mirror surface adjustments necessary to achieve a specific wavefront shape at the exit port's virtual image plane.

Users can also monitor the deformable mirror actuator control voltages, wavefront corrections, and intensity distribution in real time. Additionally, user-defined aberrations can be introduced via the demo application, and wavefront deviations can be compared to this new user-defined reference.

Since the application software provides full control of the AO Kit, it is an excellent tool for research and development or developing educational packages based on adaptive optics. For users interested in incorporating adaptive optics functionality into their own imaging systems, the Tooltips mode provided in the application can help guide the user to program an application using the SDK library of functions.

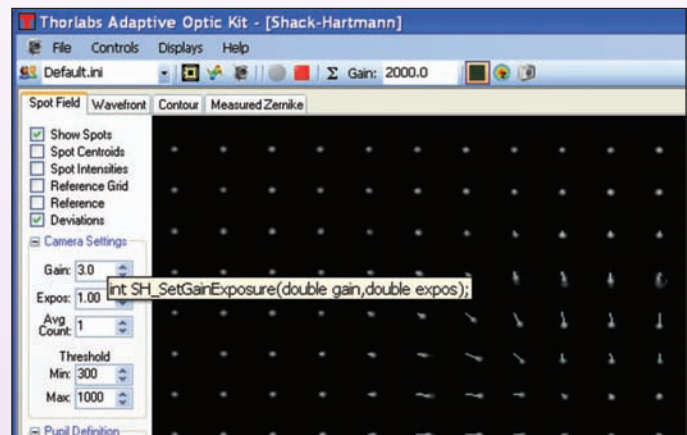
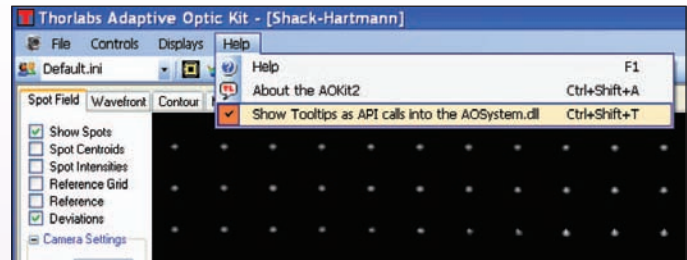

The AO Kit demo application has a Tooltip mode (top) that enables users to see particular SDK call functions associated with each control (bottom). These Tooltips assist programming of SDK-based user applications.

Adaptive Optics Kits (Page 6 of 6)

Assembled Adaptive Optics Kit

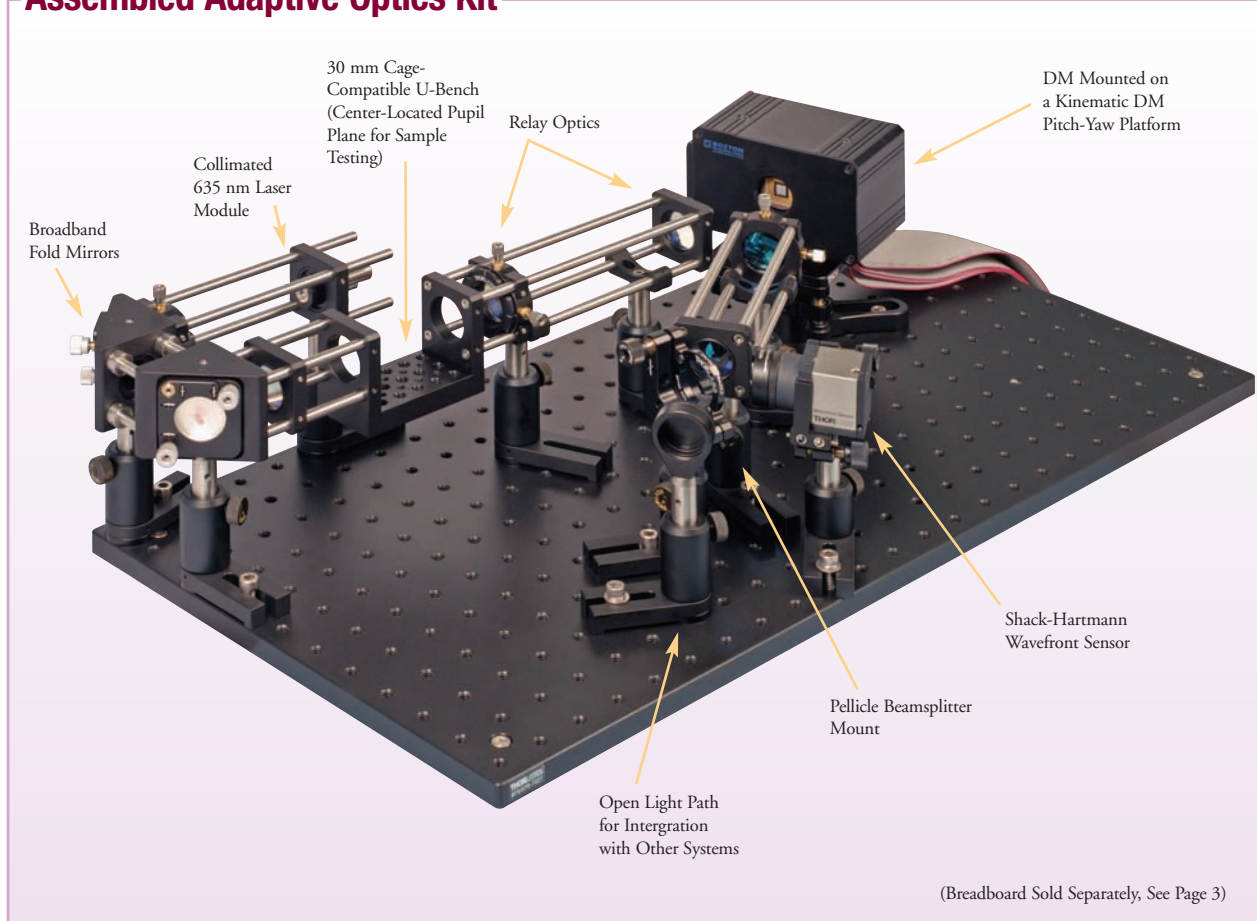

CHAPTERS ▼

Laser Scanning Microscopy

Microscopy Components

OCT Imaging Systems

OCT Components

Adaptive Optics

SECTIONS ▼

Overview

Adaptive Optics Kit

Deformable Mirrors

Wavefront Sensors

2P-AO

Adaptive Optics Kits with High-Resolution Wavefront Sensor

ITEM #	\$	£	€	RMB	DESCRIPTION
AOK1-UM01	\$ 23,000.00	£ 16,560.00	€ 20,010.00	¥ 183,310.00	AO Kit with Gold-Coated Multi-DM (140 Acutators) and CCD WFS
AOK1-UP01	\$ 23,000.00	£ 16,560.00	€ 20,010.00	¥ 183,310.00	AO Kit with Aluminum-Coated Multi-DM (140 Acutators) and CCD WFS
AOK2-UM01	\$ 12,000.00	£ 8,640.00	€ 10,440.00	¥ 95,640.00	AO Kit with Gold-Coated Mini-DM (32 Acutators) and CCD WFS
AOK2-UP01	\$ 12,000.00	£ 8,640.00	€ 10,440.00	¥ 95,640.00	AO Kit with Aluminum-Coated Mini-DM (32 Acutators) and CCD WFS

Adaptive Optics Kits with High-Speed Wavefront Sensor

ITEM #	\$	£	€	RMB	DESCRIPTION
AOK3-UM01	\$ 31,000.00	£ 22,320.00	€ 26,970.00	¥ 247,070.00	AO Kit with Gold-Coated Multi-DM (140 Acutators) and CMOS WFS
AOK3-UP01	\$ 31,000.00	£ 22,320.00	€ 26,970.00	¥ 247,070.00	AO Kit with Aluminum-Coated Multi-DM (140 Acutators) and CMOS WFS
AOK4-UM01	\$ 19,500.00	£ 14,040.00	€ 16,965.00	¥ 155,415.00	AO Kit with Gold-Coated Mini-DM (32 Acutators) and CMOS WFS
AOK4-UP01	\$ 19,500.00	£ 14,040.00	€ 16,965.00	¥ 155,415.00	AO Kit with Aluminum-Coated Mini-DM (32 Acutators) and CMOS WFS

NEW
NEW
NEW
NEW

Have you seen our...

Complete Line of Cage Components

Thorlabs' cage systems are designed to facilitate the alignment of multiple components along a common optical axis. They are available in three sizes (16 mm, 30 mm, or 60 mm) for use with Ø1/2", Ø1", and Ø2" optics, respectively. Adapters are available to switch between different cage standards. In addition, cage systems can be integrated into optical setups using mounting posts and/or lens tubes.

For more details, see page 167

