

MLJ150/M - November 28, 2023

Item # MLJ150/M was discontinued on November 28, 2023. For informational purposes, this is a copy of the website content at that time and is valid only for the stated product.

MOTORIZED HIGH-LOAD VERTICAL TRANSLATION STAGE

- Motorized Stage with 50 mm (1.97") Vertical Travel
- High Load Capacity of 20 kg (44 lbs)
- Integrated Controller Facilitates Local or Remote Control



MLJ150
50 mm (1.97") Vertical
Translation Stage with
Integrated Controller



Manual Control Keypad



Power Supply, USB, and RS232 Ports

[Hide Overview](#)

OVERVIEW

Features

- Motorized High-Load Vertical Translation Stage with Local or Remote Control
- USB and RS232 Computer Connections
- Smooth, Stepper Motor Driven Linear Motion
- Full Kinesis® or APT™ Software Control Suite (See *Motion Control Software* Tab for Details)
- Large Mounting Platform with 1/4"-20 (M6) Taps
- Location-Specific Power Supply Included

The MLJ150/(M) Motorized Vertical Translation Stage offers up to 50 mm of smooth, stepper motor driven linear height adjustment. Its integrated electronic controller allows for local control or CPU control via our software. This stage provides a rugged, height-adjustable platform ideal for mounting optomechanical sub-assemblies requiring height adjustment. It incorporates a large 5.83" x 5.16" mounting platform that is capable of moving loads up to 20 kg at up to 3 mm/s. Guards are fitted to completely eliminate finger traps and other obstructions. These features make it ideal to use as a heavy-duty lab jack.

The integrated electronic controller facilitates local control via the keypad buttons and velocity potentiometer, as seen in the drawing to the right, as well as above. Alternatively, the MLJ150/(M) can be controlled remotely via USB or RS232 connections (see the *Pin Diagram* tab for connector information) by utilizing our Kinesis® or APT™ software suites. Parameter settings can be adjusted on the PC and stored in non-volatile memory within the unit itself. When the unit is next powered up, these settings are applied automatically. This feature is

Key Specifications ^a	
Travel	50 mm (1.97")
Load (Max)	20 kg (44 lbs)
Velocity (Max)	3.0 mm/s (All Loads)
Pitch/Roll Error	<500 μ Rad
Unidirectional Repeatability	<10 μ m
Deck Parallelism	<150 μ m Over Full Range of Travel

a. Please see the *Specs* tab for a complete list of specifications.



Click to Enlarge
The Fully Extended MLJ150/(M) Mounted onto a
Nexus Optical Table by 1/4"-20 (M6) Cap
Screws

particularly useful when operating the unit manually in the absence of a PC link. Furthermore, the magnetic limit switches can be configured using flexible logic settings.

The stage offers excellent rigidity and platform parallelism. The top plate has twenty-five 1/4"-20 (M6) tapped holes with 0.31" (8.0 mm) depth, while the bottom plate has clearance slots that can be used to mount the stage to an optical breadboard, as shown to the right. The unit is supplied with a location-specific power supply with an input of 100 to 240 VAC. Please connect the power supply unit (PSU) to the stage before connecting the PSU to a power outlet. A USB cable for connection to a PC is also included.

Calibration Files

Each MLJ150(/M) stage is calibrated at the factory. Calibration enables the controller to correct for any mechanical errors present in the system. Mechanical components, such as the lead screw and linkages, can be machined only within a certain tolerance. These mechanical errors result in deviations of the actual position from the commanded position. However, the deviations are repeatable and can be compensated for using the Kinesis or APT software and included calibration files. These files are used by the Kinesis or APT software to convert the position entered by the user into the required mechanical motion. The calibration files can be downloaded by clicking on the red Docs icon (📄) next to the item # below and entering your device's serial number under "Download Calibration Data."

Software Control

USB and RS232 connectivity provides simple PC-controlled operation with two available software platforms: our new Kinesis software package, or our legacy APT software package. The Kinesis Software features new .NET controls which can be used by 3rd party developers working in the latest C#, Visual Basic, LabView or any .NET compatible languages to create custom applications. Our legacy APT software allows the user to quickly set up complex move sequences with advanced controls made possible via the ActiveX® programming environment. For example, all relevant operating parameters are set automatically by the software for Thorlabs stage and actuator products. For more details on both software packages, please see the *Motion Control Software*, *Kinesis Tutorials*, and *APT Tutorials* tabs for more details.

[Hide Specs](#)

SPECS

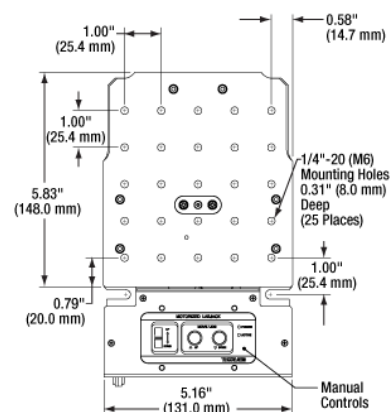

Click for

Details
The 5.83" x 5.16" (148 mm x 131 mm) top platform of the MLJ150(/M) has twenty-five 1/4"-20 (M6) mounting taps. The control keypad for manual control can be seen here.

Item #	MLJ150	MLJ150/M
Stage Specifications		
Travel	50 mm (1.97")	
Mounting Taps	1/4"-20, 0.31" Deep	M6, 8.0 mm Deep
Gear Ratio	3 to 1 (1 228 800 microsteps = 1 mm Travel)	
Load (Max)	44 lbs	20 kg
Moment Load (Max)	5 N•m (44 in-lb)	
Velocity (Max)	3.0 mm/s at All Loads	
Resolution (Theoretical)	0.8 nm	
Deck Parallelism	<150 μm Over Full Range of Travel	

Unidirectional Repeatability (Software Corrected)	<10 μm		
Bidirectional Repeatability (System Backlash)	<50 μm		
Pitch/Roll Error Over 2" (50 mm) Travel	<500 μrad		
Accuracy	<30 μm		
Lead Screw Pitch	1.0 mm		
Controller Specifications			
Microsteps per Full Step	2048		
Microsteps per Revolution of Motor	409 600		
Motor Drive Voltage	24 V		
Motor Drive Power	Up to 25 W (Peak) / 12.5 W (Avg)		
Motor Speeds	Up to 720 rpm		
Motor Specifications			
Step Angle	1.8° (50 Poles and ± 2 Phases for 360° Divided by 200, or 1.8°)		
Step Accuracy	5%		
Rated Phase Current	0.85 A		
Phase Resistance	5.4 Ω		
Phase Inductance	5.6 mH		
Holding Torque	20 N•cm		
Detent Torque	2.0 N•cm		
Operating Temperature	-20 to 40 °C (Motor Specification Only)		
Input Power Requirements			
Current	1.25 A		
Voltage	24 VDC		
Power	30 W (Peak)		
General			
Dimensions (W x D x H)	Extended	5.16" x 8.53" x 4.53"	131.0 mm x 216.7 mm x 115 mm
	Retracted	5.16" x 8.53" x 2.56"	131.0 mm x 216.7 mm x 65.0 mm
Weight	5.4 lbs		2.47 kg

[Hide Pin Diagram](#)

PIN DIAGRAM

Computer Connections

USB Type B



USB Type B to Type A Cable
Included

Pin	Description
1	Not Connected
2	TX (Controller Input)
3	RX (Controller Output)
4	Not Connected
5	Ground
6	Not Connected
7	Clear to Send (CTS) Input
8	Request to Send (RTS) Output
9	Not Connected

RS232

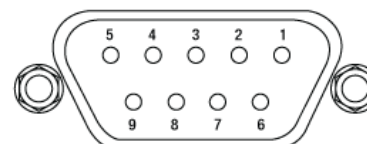

[Hide Motion Control Software](#)

MOTION CONTROL SOFTWARE

Thorlabs offers two platforms to drive our wide range of motion controllers: our Kinesis[®] software package or the legacy APT[™] (Advanced Positioning Technology) software package. Either package can be used to control devices in the Kinesis family, which covers a wide range of motion controllers ranging from small, low-powered, single-channel drivers (such as the K-Cubes[™] and T-Cubes[™]) to high-power, multi-channel, modular 19" rack nanopositioning systems (the APT Rack System).

The Kinesis Software features .NET controls which can be used by 3rd party developers working in the latest C#, Visual Basic, LabVIEW[™], or any .NET compatible languages to create custom applications. Low-level DLL libraries are included for applications not expected to use the .NET framework. A Central Sequence Manager supports integration and synchronization of all Thorlabs motion control hardware.

Our legacy APT System Software platform offers ActiveX-based controls which can be used by 3rd party developers working on C#, Visual Basic, LabVIEW[™], or any Active-X compatible languages to create custom applications and includes a simulator mode to assist in developing custom applications without requiring hardware.

By providing these common software platforms, Thorlabs has ensured that users can easily mix and match any of the Kinesis and APT controllers in a single application, while only having to learn a single set of software tools. In this way, it is perfectly feasible to combine any of the controllers from single-axis to multi-axis systems and control all from a single, PC-based unified software interface.

The software packages allow two methods of usage: graphical user interface (GUI) utilities for direct interaction with and control of the controllers 'out of the box', and a set of programming interfaces that allow custom-integrated positioning and alignment solutions to be easily programmed in the development language of choice.

A range of video tutorials is available to help explain our APT system software. These tutorials provide an overview of the software and the APT Config utility. Additionally, a tutorial video is available to explain how to select simulator mode within the software, which allows the user to experiment with the software without a controller connected. Please select the *APT Tutorials* tab above to view these videos.

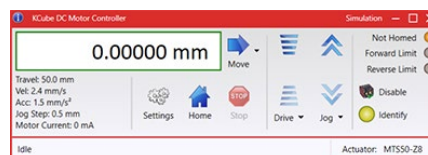

Kinesis GUI Screen



APT GUI Screen

Software

Kinesis Version 1.14.44

The Kinesis Software Package, which includes a GUI for control of Thorlabs' Kinesis and APT[™] system controllers.

Also Available:

- Communications Protocol



Software

APT Version 3.21.6

The APT Software Package, which includes a GUI for control of Thorlabs' APT[™] and Kinesis system controllers.

Also Available:

- Communications Protocol



[Hide Kinesis Tutorials](#)

KINESIS TUTORIALS

Thorlabs' Kinesis[®] software features new .NET controls which can be used by third-party developers working in the latest C#, Visual Basic, LabVIEW[™], or any .NET compatible languages to create custom applications.

C#

This programming language is designed to allow multiple programming paradigms, or languages, to be used, thus allowing for complex problems to be solved in an easy or efficient manner. It encompasses typing, imperative, declarative, functional, generic, object-oriented, and component-oriented programming. By providing functionality with this common software platform, Thorlabs has ensured that users can easily mix and match any of the Kinesis controllers in a single application, while only having to learn a single set of software tools. In this way, it is perfectly feasible to combine any of the controllers from the low-powered, single-axis to the high-powered, multi-axis systems and control all from a single, PC-based unified software interface.

The Kinesis System Software allows two methods of usage: graphical user interface (GUI) utilities for direct interaction and control of the controllers 'out of the

box', and a set of programming interfaces that allow custom-integrated positioning and alignment solutions to be easily programmed in the development language of choice.

For a collection of example projects that can be compiled and run to demonstrate the different ways in which developers can build on the Kinesis motion control libraries, click on the links below. Please note that a separate integrated development environment (IDE) (e.g., Microsoft Visual Studio) will be required to execute the Quick Start examples. The C# example projects can be executed using the included .NET controls in the Kinesis software package (see the Kinesis Software tab for details).



[Click Here for the Kinesis with C# Quick Start Guide](#)

[Click Here for C# Example Projects](#)

[Click Here for Quick Start Device Control Examples](#)



LabVIEW

LabVIEW can be used to communicate with any Kinesis- or APT-based controller via .NET controls. In LabVIEW, you build a user interface, known as a front panel, with a set of tools and objects and then add code using graphical representations of functions to control the front panel objects. The LabVIEW tutorial, provided below, provides some information on using the .NET controls to create control GUIs for Kinesis- and APT-driven devices within LabVIEW. It includes an overview with basic information about using controllers in LabVIEW and explains the setup procedure that needs to be completed before using a LabVIEW GUI to operate a device.



[Click Here to View the LabVIEW Guide](#)

[Click Here to View the Kinesis with LabVIEW Overview Page](#)



[Hide APT Tutorials](#)

APT TUTORIALS

The APT video tutorials available here fall into two main groups - one group covers using the supplied APT utilities and the second group covers programming the APT System using a selection of different programming environments.

Disclaimer: The videos below were originally produced in Adobe Flash. Following the discontinuation of Flash after 2020, these tutorials were re-recorded for future use. The Flash Player controls still appear in the bottom of each video, but they are not functional.

Every APT controller is supplied with the utilities APTUser and APTConfig. APTUser provides a quick and easy way of interacting with the APT control hardware using intuitive graphical control panels. APTConfig is an 'off-line' utility that allows various system wide settings to be made such as pre-selecting mechanical stage types and associating them with specific motion controllers.

APT User Utility

The first video below gives an overview of using the APTUser Utility. The OptoDriver single channel controller products can be operated via their front panel controls in the absence of a control PC. The stored settings relating to the operation of these front panel controls can be changed using the APTUser utility. The second video illustrates this process.

[APT User - Overview](#) [APT User - OptoDriver Settings](#)

APT Config Utility

There are various APT system-wide settings that can be made using the APT Config utility, including setting up a simulated hardware configuration and associating mechanical stages with specific motor drive channels. The first video presents a brief overview of the APT Config application. More details on creating a simulated hardware configuration and making stage associations are present in the next two videos.

[APT Config - Overview](#) [APT Config - Simulator Setup](#) [APT Config - Stage Association](#)

APT Programming

The APT Software System is implemented as a collection of ActiveX Controls. ActiveX Controls are language-independant software modules that provide both a graphical user interface and a programming interface. There is an ActiveX Control type for each type of hardware unit, e.g. a Motor ActiveX Control covers operation with any type of APT motor controller (DC or stepper). Many Windows software development environments and languages directly support ActiveX Controls, and, once such a Control is embedded into a custom application, all of the functionality it contains is immediately available to the application for automated operation. The videos below illustrate the basics of using the APT ActiveX Controls with LabVIEW, Visual Basic, and Visual C++. Note that many other languages support ActiveX including LabWindows CVI, C++ Builder, VB.NET, C#.NET, Office VBA, Matlab, HPVEE etc. Although these environments are not covered specifically by the tutorial videos, many of the ideas shown will still be relevant to using these other languages.

Visual Basic

Part 1 illustrates how to get an APT ActiveX Control running within Visual Basic, and Part 2 goes on to show how to program a custom positioning sequence.

[APT Programming Using Visual Basic - Part 1](#) [APT Programming Using Visual Basic - Part 2](#)

LabVIEW

Full Active support is provided by LabVIEW and the series of tutorial videos below illustrate the basic building blocks in creating a custom APT motion control sequence. We start by showing how to call up the Thorlabs-supplied online help during software development. Part 2 illustrates how to create an APT ActiveX Control. ActiveX Controls provide both Methods (i.e. Functions) and Properties (i.e. Value Settings). Parts 3 and 4 show how to create and wire up both the methods and properties exposed by an ActiveX Control. Finally, in Part 5, we pull everything together and show a completed LabVIEW example program that demonstrates a custom move sequence.

[APT Programming Using LabVIEW - Part 1: Accessing Online Help](#) [APT Programming Using LabVIEW - Part 2: Creating an ActiveX Control](#) [APT Programming Using LabVIEW - Part 3: Create an ActiveX Method](#)

[APT Programming Using LabVIEW - Part 4: Create an ActiveX Property](#) [APT Programming Using LabVIEW - Part 5: How to Start an ActiveX Control](#)

The following tutorial videos illustrate alternative ways of creating Method and Property nodes:

[APT Programming Using LabVIEW - Create an ActiveX Method \(Alternative\)](#) [APT Programming Using LabVIEW - Create an ActiveX Property \(Alternative\)](#)

Visual C++

Part 1 illustrates how to get an APT ActiveX Control running within Visual C++, and Part 2 goes on to show how to program a custom positioning sequence.

[APT Programming with Visual C++ - Part 1](#) [APT Programming with Visual C++ - Part 2](#)

MATLAB

For assistance when using MATLAB and ActiveX controls with the Thorlabs APT positioners, [click here](#).

To further assist programmers, a guide to programming the APT software in LabVIEW is also available [here](#).

[Hide Motorized Linear Stages](#)

MOTORIZED LINEAR STAGES







Motorized Linear Translation Stages

Thorlabs' motorized linear translation stages are offered in a range of maximum travel distances, from a stage with 20 μm of piezo translation to our 600 mm direct drive stage. Many of these stages can be assembled in multi-axis configurations, providing XY or XYZ translation. For fiber coupling applications, please see our multi-axis stages, which offer finer adjustment than our standard motorized translation stages. In addition to motorized linear translation stages, we offer motorized rotation stages and goniometers. We also offer manual translation stages.





Piezo Stages

These stages incorporate piezoelectric elements in a variety of drive mechanisms. ORIC[®] stages incorporate piezo inertia drives that use "stick-slip" friction properties to obtain extended travel ranges. Our Nanoflex[™] translation stages use standard piezo chips along with manual actuators. Elliptec[®] stages use resonant piezo motors to push and pull the moving platform through resonant elliptical motion. Our LPS710E z-axis stage features a mechanically amplified piezo design and includes a matched controller.

Piezoelectric Stages						
Product Family	ORIC [®] PD2 Open-Loop 5 mm Stage	ORIC [®] PDX2 Closed-Loop 5 mm Stage	ORIC [®] PD1 Open-Loop 20 mm Stage	ORIC [®] PD1D Open-Loop 20 mm Monolithic XY Stage	ORIC [®] PDX1 Closed-Loop 20 mm Stage	ORIC [®] PD3 Open-Loop 50 mm Stage





Click Photo to Enlarge						
Travel	5 mm		20 mm			50 mm
Maximum Velocity	10 mm/s ^a	8 mm/s (Typ.) ^b	3 mm/s ^c		20 mm/s ^b	10 mm/s ^a
Drive Type	Piezoelectric Inertia Drive					
Possible Axis Configurations	X, XY, XYZ		X, XY, XYZ	XY, XYZ	X, XY, XYZ	X, XY, XYZ
Mounting Surface Size	13 mm x 13 mm		30 mm x 30 mm			80 mm x 30 mm
Additional Details						

- a. Specified using PDXC and PDXC2 Benchtop Controllers. For performance when controlled with a KIM001 or KIM101 K-Cube Controller, see the Specs tab of the PD2 or PD3 stage presentation.
- b. Specified using PDXC and PDXC2 Benchtop Controllers.
- c. Specified using KIM101 K-Cube Controller.





Piezoelectric Stages					
Product Family	Nanoflex™ 20 μm Stage with 5 mm Actuator	Nanoflex™ 25 μm Stage with 1.5 mm Actuator	Elliptec® 28 mm Stage	Elliptec® 60 mm Stage	LPS710E 1.1 mm Vertical Stage
Click Photo to Enlarge					
Travel	20 μm + 5 mm Manual	25 μm + 1.5 mm Manual	28 mm	60.0 mm	1.1 mm
Maximum Velocity	-		180 mm/s	90 mm/s	-
Drive Type	Piezo with Manual Actuator		Resonant Piezoelectric Motor		Amplified Piezo
Possible Axis Configurations	X, XY, XYZ		X		Z
Mounting Surface Size	75 mm x 75 mm	30 mm x 30 mm	15 mm x 15 mm		21 mm x 21 mm
Additional Details					

Stepper Motor Stages

These translation stages feature removable or integrated stepper motors and long travel ranges up to 300 mm. Many of these stages either have integrated multi-axis capability (PLSXY) or can be assembled into multi-axis configurations (PLSX, LNR Series, NRT Series, and LTS Series stages). The MLJ150 stage also offers high load capacity vertical translation.





Stepper Motor Stages				
Product Family	PLSX with and without PLST(/M) Top Plate 1" Stage	PLSXY with and without PLST(/M) Top Plate 1" Stage	LNR Series 25 mm Stage	LNR Series 50 mm Stage
Click Photo to Enlarge				
Travel	1"		25 mm	50 mm

Maximum Velocity	2.0 mm/s	2.0 mm/s	50 mm/s
Possible Axis Configurations	X, XY, XYZ	X, XY, XYZ	X, XY, XYZ
Mounting Surface Size	3' x 3'	60 mm x 60 mm	100 mm x 100 mm
Additional Details			

Stepper Motor Stages					
Product Family	NRT Series 100 mm Stage	NRT Series 150 mm Stage	LTS Series 150 mm Stage	LTS Series 300 mm Stage	MLJ150 50 mm Vertical Stage
Click Photo to Enlarge					
Travel	100 mm	150 mm	150 mm	300 mm	50 mm
Maximum Velocity	30 mm/s		50 mm/s		3.0 mm/s
Possible Axis Configurations	X, XY, XYZ		X, XY, XYZ		Z
Mounting Surface Size	84 mm x 84 mm		100 mm x 90 mm		148 mm x 131 mm
Additional Details					

DC Servo Motor Stages

Thorlabs offers linear translation stages with removable or integrated DC servo motors. These stages feature low profiles and many can be assembled in multi-axis configurations.





DC Servo Motor Stages				
Product Family	MT Series 12 mm Stages	PT Series 25 mm Stages	MTS Series 25 mm Stage	MTS Series 50 mm Stage
Click Photo to Enlarge				
Travel	12 mm	25 mm	25 mm	50 mm
Maximum Velocity	2.6 mm/s		2.4 mm/s	
Possible Axis Configurations	X, XY, XYZ		X, XY, XYZ	
Mounting Surface Size	61 mm x 61 mm	101.6 mm x 76.2 mm	43 mm x 43 mm	
Additional Details				

DC Servo Motor Stages				
Product Family	M30 Series 30 mm Stage	M30 Series 30 mm Monolithic XY Stage	M150 Series 150 mm XY Stage	KVS30 30 mm Vertical Stage
Click Photo to Enlarge				
Travel	30 mm		150 mm	30 mm
Maximum Velocity	2.4 mm/s		X-Axis: 170 mm/s	8.0 mm/s

			Y-Axis: 230 mm/s	
Possible Axis Configurations	X, Z	XY, XZ	XY	Z
Mounting Surface Size	115 mm x 115 mm		272.4 mm x 272.4 mm	116.2 mm x 116.2 mm
Additional Details				

Direct Drive Stages

These low-profile stages feature integrated brushless DC servo motors for high speed translation with zero backlash. When no power is applied, the platforms of these stages have very little inertia and are virtually free running. Hence these stages may not be suitable for applications where the stage's platform needs to remain in a set position when the power is off. We do not recommend mounting these stages vertically.

Direct Drive Stages					
Product Family	DDS Series 50 mm Stage	DDS Series 100 mm Stage	DDS Series 220 mm Stage	DDS Series 300 mm Stage	DDS Series 600 mm Stage
Click Photo to Enlarge					
Travel	50 mm	100 mm	220 mm	300 mm	600 mm
Maximum Velocity	500 mm/s		300 mm/s	400 mm/s	400 mm/s
Possible Axis Configurations	X, XY		X, XY	X	X
Mounting Surface Size	60 mm x 52 mm		88 mm x 88 mm	120 mm x 120 mm	
Additional Details					

[Hide Motorized High-Load Vertical Translation Stage](#)

Motorized High-Load Vertical Translation Stage

Part Number	Description	Price	Availability
MLJ150/M	Motorized High-Load Vertical Translation Stage, 50 mm Travel, M6 Taps	\$3,368.30	Today
MLJ150	Motorized High-Load Vertical Translation Stage, 50 mm Travel, 1/4"-20 Taps	\$3,368.30	Lead Time