

WFA4106 - JAN 24, 2022

Item # WFA4106 was discontinued on JAN 24, 2022. For informational purposes, this is a copy of the website content at that time and is valid only for the stated product.

WIDEFIELD VIEWING MODULES FOR DIY CERNA® SYSTEMS

- ▶ Trinoculars for Viewing Samples via Naked Eye
- ▶ Camera Tubes and Double Camera Ports for Camera Attachment
- ▶ Breadboards and Dovetail Adapters for Custom Assemblies



CSD1002
Fixed Magnification Double Camera Port



WFA4101
0.75X Camera Tube



CSA1003
D1N Dovetail Adapter with 60 mm Cage Mounting Holes



LAURE1
Trinoculars with 10X Eyepieces



Application Idea
User-Built Epi-Illumination and Widefield Module Using a Breadboard Top, Dovetail Adapters, and Thorlabs' Optomechanics

[Hide Overview](#)

OVERVIEW

Features

- Trinoculars with 10X Eyepieces and a Camera Port
- Camera Tubes Mechanically Align a Camera at the Image Plane with 1X, 0.75X, 0.7X, or 0.5X Magnification
- Double Camera Ports Allow Two Cameras to be Attached Simultaneously
- Breadboards and Dovetail Adapters for Creating Custom Widefield Assemblies Using Thorlabs Cage Systems and SM-Threaded Lens Tubes

These widefield viewing accessories allow images obtained from a sample to be viewed and recorded.

Trinoculars

Upright trinoculars are offered with 10X eyepieces to visualize images in the visible and near-infrared (NIR) regions of the spectrum. Each trinocular contains a top-located camera port that accepts a camera attached to a camera tube and a side-located lever that allows the user to switch between using the eyepieces and camera. They each have an internal 200 mm focal length tube lens that focuses the incoming light onto the eyepieces and above the camera port.

Thorlabs also separately offers the eyepiece and IR blocking filter included in the LAURE1 trinoculars. The eyepiece provides 10X magnification, while the filter transmits wavelengths from 375 nm to 650 nm and blocks wavelength from 700 nm to 1400 nm. An eyepiece adapter is also available for connecting custom image detection setups to either eyepiece of the trinoculars. This adapter features internal SM1 (1.035"-40) threading for Ø1" lens tubes, external SM2 (2.035"-40) threading for Ø2" lens tubes, and four 4-40 tapped holes for 30 mm cage systems.

Camera Tubes

Camera tubes are designed to place the camera at the focal plane of the system's tube lens, thus allowing the camera to image the FOV on the sensor. They can be mounted independently or in conjunction with trinoculars, double camera ports, or other assemblies. Options are available with and without a built-in tube lens and fine focus camera adjuster. In order to provide a balance between the size of the FOV displayed on the camera and the resolution of the microscope, we offer these camera tubes in several magnifications. For information on how to calculate the magnification and image area, please see the *Magnification & FOV* tab.

Double Camera Ports

Double camera ports allow for the simultaneous attachment of up to two cameras or a trinocular onto a microscope system, thus allowing for greater experimental flexibility. They are available with or without included optics to direct light to separate, independently configurable cameras.

Breadboard Tops

Breadboards have an array of 1/4"-20 mounting taps to provide the means to construct custom-designed widefield viewing apparatuses and epi-illumination pathways on top of a DIY Cerna® microscope body. They are available in two sizes: 14.00" x 11.00" and 18.00" x 4.60" (350.0 mm x 275.0 mm and 450.0 mm x 116.8 mm for metric versions). The larger version provides a larger work surface with more mounting taps while the smaller version does not restrict approach angles. The small version also has eight 4-40 taps around the Ø1.5" through hole for 30 mm and 60 mm cage systems.



Click to Enlarge
Trinoculars with 10X Eyepieces and Camera Mounted on a 1X Camera Tube for Imaging an Epi-Illuminated Sample

Did You Know?

Multiple optical elements, including the microscope objective, tube lens, and eyepieces, together define the magnification of a system. See the *Magnification & FOV* tab to learn more.



Dovetail Adapters

Dovetail interfaces are used to facilitate the attachment of many DIY Cerna modules, including the widefield viewing components below. Various dovetail adapters are provided to adapt Thorlabs' Cerna assemblies to standard Thorlabs optomechanical systems, such as SM-threaded lens tubes, 30 mm cage systems, and 60 mm cage systems. Please see the *Microscope Dovetails* tab for more information on the type of dovetail mounts used and their specifications, and the *DIY Cerna Interfaces* tab for a comprehensive compatibility table for the Cerna product line.

[Hide Microscope Dovetails](#)

MICROSCOPE DOVETAILS

Introduction to Microscope Dovetails

Dovetails are used for mechanical mating and optical port alignment of microscope components. Components are connected by inserting one dovetail into another, then tightening one or more locking setscrews on the female dovetail. Dovetails come in two shapes: linear and circular. Linear dovetails allow the mating components to slide before being locked down, providing flexible positioning options while limiting unneeded degrees of freedom. Circular dovetails align optical ports on different components, maintaining a single optical axis with minimal user intervention.



Click to Enlarge
This photo shows the male 95 mm dovetail on the microscope body and the female 95 mm dovetail on the CSA1002 Fixed Arm.



Click to Enlarge
This photo shows the male D1N dovetail on the trinoculars next to the female D1N dovetail on the epi-illumination arm.

Thorlabs manufactures many components which use dovetails to mate with our own components or those of other manufacturers. To make it easier to identify dovetail compatibility, we have developed a set of dovetail designations. The naming convention of these designations is used only by Thorlabs and not other microscope manufacturers. The table to the right lists all the dovetails Thorlabs makes, along with their key dimensions.

In the case of Thorlabs' Cerna® microscopes, different dovetail types are used on different sections of the microscope to ensure that only compatible components can be mated. For example, our WFA2002 Epi-Illuminator Module has a male D1N dovetail that mates with the female D1N dovetail on the microscope body's epi-illumination arm, while the CSS2001 XY Microscopy Stage has a female D1Y dovetail that mates with the male D1Y dovetail on the CSA1051 Mounting Arm.

To learn which dovetail type(s) are on a particular component, consult its mechanical drawing, available by clicking on the red Docs icon (📄) below. For adapters with a female dovetail, the drawing also indicates the size of the hex key needed for the locking setscrew(s). It is important to note that mechanical compatibility does not ensure optical compatibility. Information on optical compatibility is available from Thorlabs' web presentations.

For customers interested in machining their own dovetails, the table to the right gives the outer diameter and angle (as defined by the drawings below) of each Thorlabs dovetail designation. However, the dovetail's height must be determined by the user, and for circular dovetails, the user must also determine the inner diameter and bore diameter. These quantities can vary for dovetails of the same type. One can use the intended mating part to verify compatibility.

In order to reduce wear and simplify connections, dovetails are often machined with chamfers, recesses, and other mechanical features. Some examples of these variations are shown by the drawings below.

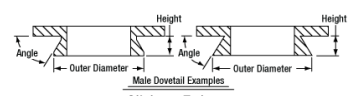

Male Dovetail Examples
Click to Enlarge
Two examples of how circular male dovetails can be manufactured.

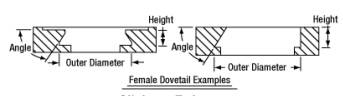

Female Dovetail Examples
Click to Enlarge
Two examples of how circular female dovetails can be manufactured.

Thorlabs Dovetail Reference ^a			
Type	Shape	Outer Dimension	Angle
95 mm	Linear	95 mm	45°
D1N	Circular	Ø2.018"	60°
D2N ^b	Circular	Ø1.50"	90°
D2NB ^b	Circular	Ø1.50"	90°
D3N	Circular	Ø45 mm	70°
D5N	Circular	Ø1.58"	90°
D6N	Circular	Ø1.90"	90°
D7N	Circular	Ø2.05"	90°
D1T	Circular	Ø1.50"	60°
D3T	Circular	Ø1.65"	90°
D1Y	Circular	Ø107 mm	60°
D2Y	Circular	Ø2.32"	50°
D3Y	Circular	Ø1.75"	90°
D4Y	Circular	Ø56 mm	60°
D5Y	Circular	Ø46 mm	60°
D6Y	Circular	Ø41.9 mm	45°
D1Z	Circular	Ø54 mm	60°
D2Z	Circular	Ø57 mm	60°
D3Z	Circular	Ø54 mm	45°

a. These dovetail designations are specific to Thorlabs products and are not used by other microscope manufacturers.
b. D2N and D2NB dovetails have the same outer diameter and angle, as defined by the drawings below. The D2N designation does not specify a height. The D2NB designation specifies a dovetail height of 0.40" (10.2 mm).

[Hide Magnification & FOV](#)

MAGNIFICATION & FOV

Magnification and Sample Area Calculations

Magnification

The magnification of a system is the multiplicative product of the magnification of each optical element in the system. Optical elements that produce magnification include objectives, camera tubes, and trinocular eyepieces, as shown in the drawing to the right. It is important to note that the magnification quoted in these products' specifications is usually only valid when all optical elements are made by the same manufacturer. If this is not the case, then the magnification of the system can still be calculated, but an effective objective magnification should be calculated first, as described below.

Magnification and FOV Calculator

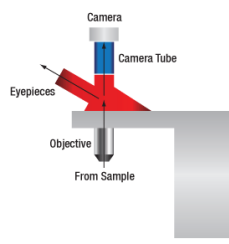

To adapt the examples shown here to your own microscope, please use our Magnification and FOV Calculator, which is available for download by clicking on the red button above. Note the calculator is an Excel spreadsheet that uses macros. In order to use the calculator, macros must be enabled. To enable macros, click the "Enable Content" button in the yellow message bar upon opening the file.

When viewing an image with a camera, the system magnification is the product of the objective and camera tube magnifications. When viewing an image with trinoculars, the system magnification is the product of the objective and eyepiece magnifications.

Example 1: Camera Magnification

When imaging a sample with a camera, the image is magnified by the objective and the camera tube. If using a 20X Nikon objective and a 0.75X Nikon camera tube, then the image at the camera has $20X \times 0.75X = 15X$ magnification.

Example 2: Trinocular Magnification

When imaging a sample through trinoculars, the image is magnified by the objective and the eyepieces in the trinoculars. If using a 20X Nikon objective and Nikon trinoculars with 10X eyepieces, then the image at the eyepieces has $20X \times 10X = 200X$ magnification. Note that the image at the eyepieces does not pass through the camera tube, as shown by the drawing to the right.

Using an Objective with a Microscope from a Different Manufacturer

Magnification is not a fundamental value: it is a derived value, calculated by assuming a specific tube lens focal length. Each microscope manufacturer has adopted a different focal length for their tube lens, as shown by the table to the right. Hence, when combining optical elements from different manufacturers, it is necessary to calculate an *effective* magnification for the objective, which is then used to calculate the magnification of the system.

Manufacturer	Tube Lens Focal Length
Leica	f = 200 mm
Mitutoyo	f = 200 mm
Nikon	f = 200 mm
Olympus	f = 180 mm
Thorlabs	f = 200 mm
Zeiss	f = 165 mm

The rows highlighted in green denote manufacturers that do not use f = 200 mm tube lenses.

The effective magnification of an objective is given by Equation 1:

$$\text{Effective Objective Magnification} = \text{Design Magnification} \times \frac{f_{\text{Tube Lens in Microscope}} \text{ (mm)}}{f_{\text{Design Tube Lens of Objective}} \text{ (mm)}} \quad (\text{Eq. 1})$$

Here, the Design Magnification is the magnification printed on the objective, $f_{\text{Tube Lens in Microscope}}$ is the focal length of the tube lens in the microscope you are using, and $f_{\text{Design Tube Lens of Objective}}$ is the tube lens focal length that the objective manufacturer used to calculate the Design Magnification. These focal lengths are given by the table to the right.

Note that Leica, Mitutoyo, Nikon, and Thorlabs use the same tube lens focal length; if combining elements from any of these manufacturers, no conversion is needed. Once the effective objective magnification is calculated, the magnification of the system can be calculated as before.

Example 3: Trinocular Magnification (Different Manufacturers)

When imaging a sample through trinoculars, the image is magnified by the objective and the eyepieces in the trinoculars. This example will use a 20X Olympus objective and Nikon trinoculars with 10X eyepieces.

Following Equation 1 and the table to the right, we calculate the effective magnification of an Olympus objective in a Nikon microscope:

$$\text{Effective Objective Magnification} = 20X \times \frac{200 \text{ mm}}{180 \text{ mm}} = 22.2X$$

The effective magnification of the Olympus objective is 22.2X and the trinoculars have 10X eyepieces, so the image at the eyepieces has $22.2X \times 10X = 222X$ magnification.

Sample Area When Imaged on a Camera

When imaging a sample with a camera, the dimensions of the sample area are determined by the dimensions of the camera sensor and the system magnification, as shown by Equation 2.

$$\text{Sample Area (mm} \times \text{mm)} = \frac{\text{Camera Sensor Width (mm)}}{\text{System Magnification}} \times \frac{\text{Camera Sensor Height (mm)}}{\text{System Magnification}} \quad (\text{Eq. 2})$$

The camera sensor dimensions can be obtained from the manufacturer, while the system magnification is the multiplicative product of the objective magnification and the camera tube magnification (see Example 1). If needed, the objective magnification can be adjusted as shown in Example 3.

Sample Area When Imaged on a Camera

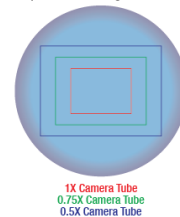

As the magnification increases, the resolution improves, but the field of view also decreases. The dependence of the field of view on magnification is shown in the schematic to the right.

Example 4: Sample Area

The dimensions of the camera sensor in Thorlabs' 1501M-USB Scientific Camera are 8.98 mm × 6.71 mm. If this camera is used with the Nikon objective and trinoculars from Example 1, which have a system magnification of 15X, then the image area is:

$$\text{Sample Area (mm} \times \text{mm)} = \frac{8.98 \text{ mm}}{15X} \times \frac{6.71 \text{ mm}}{15X} = 599 \mu\text{m} \times 447 \mu\text{m}$$

Sample Area Examples

The images of a mouse kidney below were all acquired using the same objective and the same camera. However, the camera tubes used were different. Read from left to right, they demonstrate that decreasing the camera tube magnification enlarges the field of view at the expense of the size of the details in the image.

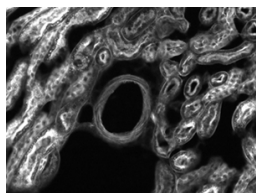

Click to Enlarge
Acquired with 1X Camera Tube (Item # WFA4100)

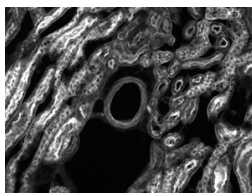

Click to Enlarge
Acquired with 0.75X Camera Tube (Item # WFA4101)

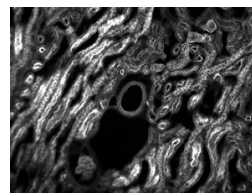

Click to Enlarge
Acquired with 0.5X Camera Tube (Item # WFA4102)

HYPERSPECTRAL IMAGING

Application Idea: Hyperspectral Imaging

In hyperspectral imaging, a stack of spectrally separated, two-dimensional images is acquired. This technique is frequently used in microscopy, biomedical imaging, and machine vision, as it allows quick sample identification and analysis.

Hyperspectral imaging obtains images with significantly better spectral resolution than that provided by standalone color cameras. Color cameras represent the entire spectral range of an image by using three relatively wide spectral channels—red, green, and blue. In contrast, hyperspectral imaging systems incorporate optical elements such as liquid crystal tunable bandpass filters or diffraction gratings, which create spectral channels with significantly narrower bandwidths.



Click to Enlarge
A hyperspectral imaging system built using Thorlabs' Cerna Microscopy Platform, KURIOS-VB1 Tunable Bandpass Filter, and Monochrome Scientific Camera. Several components shown here were modified from their stock configuration.

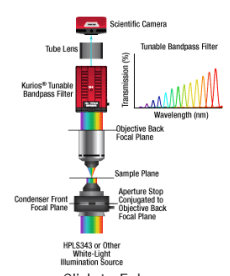

Click to Enlarge
Schematic of Hyperspectral Imaging

Thorlabs' Cerna™ microscopy platform, Kurios™ tunable filters, and scientific-grade cameras are easily adapted to hyperspectral imaging. The Cerna platform is a modular microscopy system that integrates with Thorlabs' SM lens tube construction systems and supports transmitted light illumination. Kurios tunable filters have SM-threaded interfaces for connections to the Cerna platform and our cameras. In addition, Kurios filters include software and a benchtop controller with external triggers, which enable fast, automated, synchronized wavelength switching and image capture.

Example Image Stack

The data in the images and video below demonstrate the hyperspectral imaging technique. Figure 1 depicts two images of a mature *capsella bursa-pastoris* embryo (also known as shepherd's-purse) taken with a Kurios filter set to center wavelengths of 500 nm and 650 nm. These two images show that an entire field of view is acquired at each spectral channel. Figure 2 is a video containing 31 images of the same sample, taken at center wavelengths from 420 nm to 730 nm in 10 nm steps. (10 nm is not the spectral resolution; the spectral resolution is set by the FWHM bandwidth at each wavelength.) In Figure 3, images from each spectral channel are used to determine the color of each pixel and assemble a color image. Figure 3 also demonstrates that a broadband spectrum is acquired at each pixel, permitting spectroscopic identification of different sample features within the field of view.

Kurios tunable filters offer a number of advantages for hyperspectral imaging. Unlike approaches that rely upon angle-tunable filters or manual filter swapping, Kurios filters use no moving parts, enabling vibrationless wavelength switching on millisecond timescales. Because the filter is not moved or exchanged during the measurement, the data is not subject to "pixel shift" image registration issues. Our filters also include software and a benchtop controller with external triggers, making them easy to integrate with data acquisition and analysis programs.

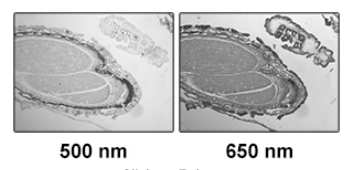

Click to Enlarge
Figure 1: Two images of a mature *capsella bursa-pastoris* embryo taken at different center wavelengths. The entire field of view is acquired for each spectral channel.

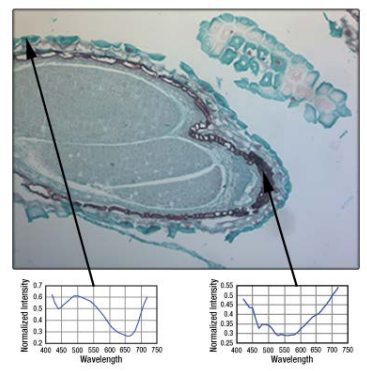

Click to Enlarge
Figure 3: A color image of the mature *capsella bursa-pastoris* embryo, assembled using the entire field of view acquired in each spectral channel, as shown in Figure 1. By acquiring across multiple channels, a spectrum for each pixel in the image is obtained.

[Hide DIY Cerna Interfaces](#)

DIY CERNA INTERFACES

Standard Mechanical Interfaces on DIY Cerna® Components

The table below gives the dovetail, optical component threads, and cage system interfaces that are present on each DIY Cerna component. If a DIY Cerna component does not have one of the standard interfaces in the table, it is not listed here. Please note that mechanical compatibility does not ensure optical compatibility. Information on optical compatibility is available from Thorlabs' web presentations.

Item #	Microscope Dovetails										Optical Component Threads ^a				Cage Systems ^b	
	95 mm	D1N	D2N	D2NB	D3N	D5N	D1T	D3T	D1Y	D5Y	C-Mount ^c (1.00"-32)	SM1 ^d (1.035"-40)	SM30 (M30.5x0.5)	SM2 ^e (2.035"-40)	30 mm ^d	60 mm ^e
2CM1											Internal & External			Internal		Yes
2CM2											Internal & External			Internal	Yes	

BSA2000 ^f					Female												
CEA1350	Male	Female															Yes
CEA1400	Male	Female															Yes
CEA1500	Male	Female															Yes
CEA1600	Male	Female															Yes
CFB1500	Male																
CSA1000	Female																
CSA1001	Female											Internal				Yes	
CSA1002	Female												Internal			Yes	
CSA1003		Female															Yes
CSA1051	Female									Male							
CSA1200 ^{f,g}																	Yes
CSA1400 ^f							Female										Yes
CSA1500 ^{f,h}																	
CSA2000 ^f					Female										Internal		Yes
CSA2001					Female										External		
CSA2100 ^f															Internal		Yes
CSA3000(/M)		Male															
CSA3010(/M)		Male														Yes	Yes
Item #	95 mm	D1N	D2N	D2NB	D3N	D5N	D1T	D3T	D1Y	D5Y	C-Mount	SM1	SM30	SM2	30 mm	60 mm	
CSC1001					Male												
CSC1002					Male												
CSC2001					Male												
CSD1001		Male & Female		Female													
CSD1002		Male & Female									External						
CSE2000		Male & Female															Yes
CSE2100		Male & Female							Female			Internal				Yes	Yes
CSE2200		Male & Female							Female			Internal				Yes	Yes
CSN100 ^{f,i}																	Yes
CSN200 ⁱ							Male										
CSN210 ⁱ							Male										
CSN1201 ^{g,i}																	
CSN1202 ^{g,j}																	
CSS2001											Female						
LAURE1		Male	Female														
LAURE2		Male	Female														
LCPN1					Male								Internal			Yes	Yes
LCPN2		Male											Internal			Yes	Yes
LCPN3		Male									Female		Internal				Yes
Item #	95 mm	D1N	D2N	D2NB	D3N	D5N	D1T	D3T	D1Y	D5Y	C-Mount	SM1	SM30	SM2	30 mm	60 mm	
OPX2400(/M)		Male & Female												Internal			Yes
SM1A70												External	Internal				
SM1A58			Male	Male								Internal		External		Yes	
SM2A56								Male						External			
TC1X			Male														
WFA0150	Female																
WFA1000																	Yes
WFA1010												Internal					Yes
WFA1020												Internal					Yes
WFA1051												Internal					Yes
WFA1100																	Yes
WFA2001		Male & Female										Internal & External					
WFA2002		Male & Female										Internal				Yes	

WFA4002		Male					Female										
WFA4100		Male										External	Internal				
WFA4101		Male										External	Internal				
WFA4102		Male										External	Internal				
WFA4106			Male									External					
WFA4110		Male													External		
WFA4111		Male													External		
WFA4112				Male								External					
Item #	95 mm	D1N	D2N	D2NB	D3N	D5N	D1T	D3T	D1Y	D5Y	C-Mount	SM1	SM30	SM2	30 mm	60 mm	
XT95RC1(/M)	Female																
XT95RC2(/M)	Female																
XT95RC3(/M)	Female																
XT95RC4(/M)	Female																
XT95P12(/M)	Female																
ZFM1020	Female																
ZFM1030	Female																
ZFM2020	Female																
ZFM2030	Female																

- a. Thorlabs' optical component thread adapters can be used to convert between C-Mount threads, SM1 threads, SM2 threads, and virtually every other optical thread standard.
- b. Our cage system size adapters and drop-in adapter can be used to convert between 16 mm, 30 mm, and 60 mm cage systems.
- c. C-Mount and CS-Mount standards feature the same 1.00"-32 threads, but C-Mounts have a 5 mm longer flange-to-sensor distance.
 - d. Our 30 mm cage plates can convert between SM1 lens tubes and 30 mm cage systems.
 - e. Our 60 mm cage plates can convert between SM2 lens tubes and 60 mm cage systems.
 - f. Attach to a ZFM focusing module to add a female 95 mm dovetail.
 - g. The CSA1200 mounting arm is compatible with the CSN1201 and CSN1202 nosepieces.
- h. This blank arm is designed for custom DIY machining for non-standard components, threads, and bores..
 - i. This nosepiece directly accepts M32 x 0.75 objective threads.
 - j. This nosepiece directly accepts M25 x 0.75 objective threads.
 - k. This nosepiece directly accepts RMS (0.800"-36) objective threads.

[Hide Cerna Videos](#)

CERNA VIDEOS

Building a Cerna® Microscope

The Cerna microscopy platform's large working volume and system of dovetails make it straightforward to connect and position the components of the microscope. This flexibility enables simple and stable set up of a preconfigured microscope, and provides easy paths for later upgrades and modification. See below for a couple examples of the assembly of some DIY Cerna microscopes.

DIY Cerna Design and Assembly

[Hide Microscope Guide](#)

MICROSCOPE GUIDE

Elements of a Microscope

This overview was developed to provide a general understanding of a Cerna® microscope. Click on the different portions of the microscope graphic to the right or use the links below to learn how a Cerna microscope visualizes a sample.

- Terminology
- Microscope Body
- Illumination
- Sample Viewing/Recording
- Sample/Experiment Mounting

Click on the different parts of the microscope to explore their functions.

Terminology

Arm: Holds components in the optical path of the microscope.

Bayonet Mount: A form of mechanical attachment with tabs on the male end that fit into L-shaped slots on the female end.

Bellows: A tube with accordion-shaped rubber

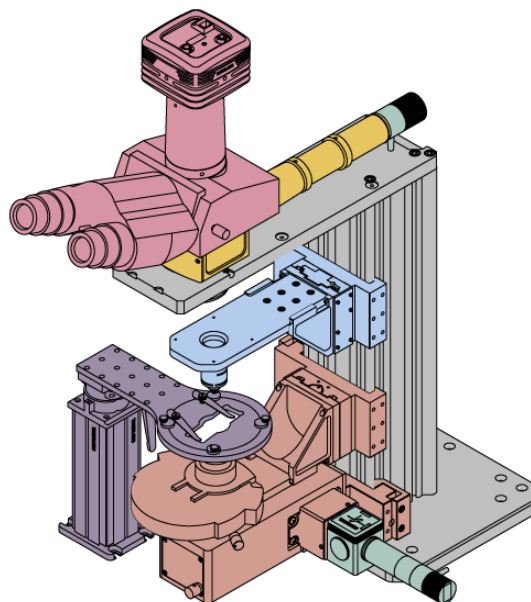

sides for a flexible, light-tight extension between the microscope body and the objective.

Breadboard: A flat structure with regularly spaced tapped holes for DIY construction.

Dovetail: A form of mechanical attachment for many microscopy components. A linear dovetail allows flexible positioning along one dimension before being locked down, while a circular dovetail secures the component in one position. See the *Microscope Dovetails* tab or here for details.

Epi-Illumination: Illumination on the same side of the sample as the viewing apparatus. Epi-fluorescence, reflected light, and confocal microscopy are some examples of imaging modalities that utilize epi-illumination.

Filter Cube: A cube that holds filters and other optical elements at the correct orientations for microscopy. For example, filter cubes are essential for fluorescence microscopy and reflected light microscopy.

Köhler Illumination: A method of illumination that utilizes various optical elements to defocus and flatten the intensity of light across the field of view in the sample plane. A condenser and light collimator are necessary for this technique.

Nosepiece: A type of arm used to hold the microscope objective in the optical path of the microscope.

Optical Path: The path light follows through the microscope.

Rail Height: The height of the support rail of the microscope body.

Throat Depth: The distance from the vertical portion of the optical path to the edge of the support rail of the microscope body. The size of the throat depth, along with the working height, determine the working space available for microscopy.

Trans-Illumination: Illumination on the opposite side of the sample as the viewing apparatus. Brightfield, differential interference contrast (DIC), Dot gradient contrast, and darkfield microscopy are some examples of imaging modalities that utilize trans-illumination.

Working Height: The height of the support rail of the microscope body plus the height of the base. The size of the working height, along with the throat depth, determine the working space available for microscopy.

Microscope Body

The microscope body provides the foundation of any Cerna microscope. The support rail utilizes 95 mm rails machined to a high angular tolerance to ensure an aligned optical path and perpendicularity with the optical table. The support rail height chosen (350 - 600 mm) determines the vertical range available for experiments and microscopy components. The 7.74" throat depth, or distance from the optical path to the support rail, provides a large working space for experiments. Components attach to the body by way of either a linear dovetail on the support rail, or a circular dovetail on the epi-illumination arm (on certain models). Please see the *Microscope Dovetails* tab or here for further details.

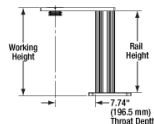

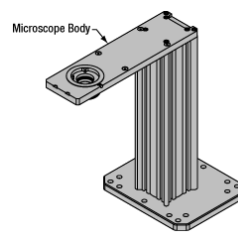

Click to Enlarge Body Details



Enlarge Cerna Microscope Body

Click to

	
Microscope Bodies	Microscope Translator

Illumination

Using the Cerna microscope body, a sample can be illuminated in two directions: from above (epi-illumination, see yellow components to the right) or from below (trans-illumination, see orange components to the right).

Epi-illumination illuminates on the same side of the sample as the viewing apparatus; therefore, the light from the illumination source (green) and the light from the sample plane share a portion of the optical path. It is used in fluorescence, confocal, and reflected light microscopy. Epi-illumination modules, which direct and condition light along the optical path, are attached to the epi-illumination arm of the microscope body via a circular D1N dovetail (see the *Microscope Dovetails* tab or here for details). Multiple epi-illumination modules are available, as well as breadboard tops, which have regularly spaced tapped holes for custom designs.

Trans-illumination illuminates from the opposite side of the sample as the viewing apparatus. Example imaging modalities include brightfield, differential interference contrast (DIC), Dotd gradient contrast, oblique, and darkfield microscopy. Trans-illumination modules, which condition light (on certain models) and direct it along the optical path, are attached to the support rail of the microscope body via a linear dovetail (see *Microscope Dovetails* tab or here). Please note that certain imaging modalities will require additional optics to alter the properties of the beam; these optics may be easily incorporated in the optical path via lens tubes and cage systems. In addition, Thorlabs offers condensers, which reshape input collimated light to help create optimal Köhler illumination. These attach to a mounting arm, which holds the condenser at the throat depth, or the distance from the optical path to the support rail. The arm attaches to a focusing module, used for aligning the condenser with respect to the sample and trans-illumination module.

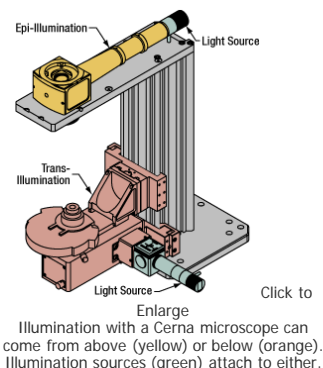

Epi-Illumination Modules	Breadboards & Body Attachments	Brightfield	DIC	Dotd	Condensers	Condenser Mounting	Light Sources

Sample Viewing/Recording

Once illuminated, examining a sample with a microscope requires both focusing on the sample plane (see blue components to the right) and visualizing the resulting image (see pink components).

A microscope objective collects and magnifies light from the sample plane for imaging. On the Cerna microscope, the objective is threaded onto a nosepiece, which holds the objective at the throat depth, or the distance from the optical path to the support rail of the microscope body. This nosepiece is secured to a motorized focusing module, used for focusing the objective as well as for moving it out of the way for sample handling. To ensure a light-tight path from the objective, the microscope body comes with a bellows (not pictured).

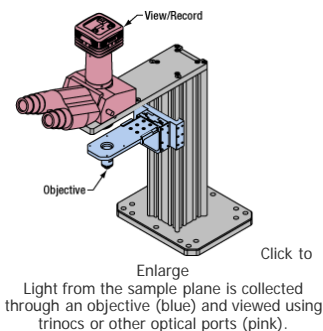

Various modules are available for sample viewing and data collection. Trinoculars have three points of vision to view the sample directly as well as with a camera. Double camera ports redirect or split the optical path among two viewing channels. Camera tubes increase or decrease the image magnification. For data collection, Thorlabs offers both cameras and photomultiplier tubes (PMTs), the latter being necessary to detect fluorescence signals for confocal microscopy. Breadboard tops provide functionality for custom-designed data collection setups. Modules are attached to the microscope body via a circular dovetail (see the *Microscope Dovetails* tab or here for details).

Objectives & Accessories	Objective Mounting	Sample Viewing	Cameras	PMTs	Breadboards & Body Attachments

Sample/Experiment Mounting

Various sample and equipment mounting options are available to take advantage of the large working space of this microscope system. Large samples and ancillary equipment can be mounted via mounting platforms, which fit around the microscope body and utilize a breadboard design with regularly spaced tapped through holes. Small samples can be mounted on rigid stands (for example, see the purple component to the right), which have holders for different methods of sample preparation and data collection, such as slides, well plates, and petri dishes. For more traditional sample mounting, slides can also be mounted directly onto the microscope body via a manual XY stage. The rigid stands can translate by way of motorized stages (sold separately), while the mounting platforms contain built-in mechanics for motorized or manual translation. Rigid stands can also be mounted on top of the mounting platforms for independent and synchronized movement of multiple instruments, if you are interested in performing experiments simultaneously during microscopy.

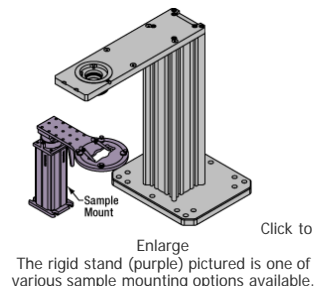

--	--	--	--	--

Close



For sample viewing, Thorlabs offers trinoculars, double camera ports, and camera tubes. Light from the sample plane can be collected via cameras, photomultiplier tubes (PMTs), or custom setups using breadboard tops. Click here for additional information about viewing samples with a Cerna microscope.

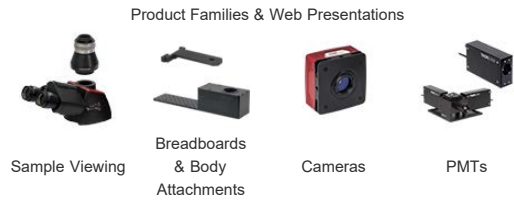

Close

Microscope objectives are held in the optical path of the microscope via a nosepiece. Click here for additional information about viewing a sample with a Cerna microscope.



Close

Large and small experiment mounting options are available to take advantage of the large working space of this microscope. Click here for additional information about mounting a sample for microscopy.

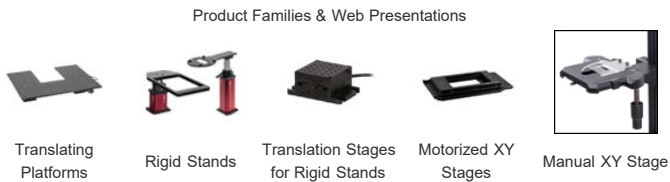

Close

Thorlabs offers various light sources for epi- and trans-illumination. Please see the full web presentation of each to determine its functionality within the Cerna microscopy platform.



Close

Epi-illumination illuminates the sample on the same side as the viewing apparatus. Example imaging modalities include fluorescence, confocal, and reflected light microscopy. Click here for additional information on epi-illumination with Cerna.

Product Families & Web Presentations



Close

Trans-illumination illuminates from the opposite side of the sample as the viewing apparatus. Example imaging modalities include brightfield, differential interference contrast (DIC), Dot gradient contrast, oblique, and darkfield microscopy. Click here for additional information on trans-illumination with Cerna.



Close

The microscope body provides the foundation of any Cerna microscope. The 7.74" throat depth provides a large working space for experiments. Click here for additional information about the Cerna microscope body.

Product Families & Web Presentations



[Hide Trinoculars](#)

Trinoculars



Click to Enlarge LAURE1 Trinocular Being Attached to a Cerna Epi-Illumination Module

- ▶ 10X Eyepieces to Observe FOV with Naked Eye
- ▶ Upright-Image Trinoculars
- ▶ Available With or Without IR Filters for Eye Protection
- ▶ Top-Located Port for Camera Attachment Using Camera Tube
- ▶ Adjustable Interpupil Distance
- ▶ Male D1N Dovetail on Bottom

These trinoculars are ideal for viewing a sample with the naked eye using the included 10X eyepieces or with a camera connected to the top-located camera port via a camera tube (camera and camera tube sold separately). A lever located on the side of the housing directs the incoming light to either the eyepieces or the camera.

Each camera port has either a D2N or D5N female dovetail connector that accepts a compatible camera tube, which mechanically positions the camera sensor at the image plane and ensures parfocality with the eyepieces. See the table below for compatible camera tubes. A 2 mm hex key (not included) is used to lock the camera tube in place.

A bottom-located D1N male dovetail connector is provided to attach the trinoculars to other modules such as Cerna microscope bodies, epi-illuminator modules, or double camera ports (available below). For customers interested in constructing a custom system, adapters (available below) that attach directly to the D1N or D2N dovetails on these trinoculars provide compatibility with Thorlabs' 30 mm Cage Systems and SM-Threaded Lens Tubes.

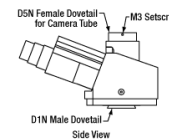
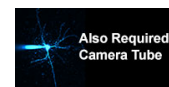

Click for Details Drawing of WFA4002 Trinoculars

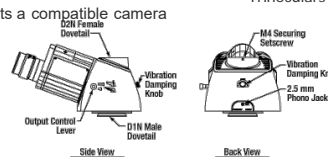

Click for Details Drawing of LAURE1 and LAURE2 Trinoculars

Upright-Image Trinoculars

The WFA4002 and LAUREx trinoculars produce an upright image of a sample. The WFA4002 and LAURE1 each include a filter before the eyepieces that blocks NIR light. This filter will not block NIR light that is sent to the camera port and it cannot be removed. The LAURE2 does not ship with a blocking filter, but accepts the TF1 NIR blocking filter, available below, with the use of an SM30RR retaining ring (not included).

The drawings for the WFA4002, LAURE1, and LAURE2 trinoculars are shown to the right. The WFA4002 trinoculars have an internal ITL200 tube lens, while the LAUREx trinoculars have an internal TTL200 tube lens. Both tube lenses have a focal length of 200 mm; see the expandable drawings to the right for the location of the image plane.

The LAURE1 and LAURE2 trinoculars incorporate several additional features. A red vibration damping knob on the side of the housing allows the detent mechanism on the carriage slider to be disengaged, which is useful for electrophysiology applications that require minimal vibration when switching between the eyepiece and camera port. These trinoculars also include a carriage position indicator switch via a 2.5 mm phono jack, allowing users to connect a laser interlock; it is designed to break the circuit in a laser interlock when the carriage is in the eyepiece output position. For custom-built optical detection systems, these trinoculars have 4-40 taps on the top D2N dovetail connector for compatibility with 30 mm cage systems and 4-40 taps on the bottom D1N dovetail for compatibility with 60 mm cage systems.

System Magnification

The total system magnification will be the multiplicative product of the objective magnification and the eyepieces or camera tube magnification, depending on which

is being used. To achieve an objective's stated magnification, the objective must have been designed for systems using a 200 mm tube lens. Please note that the eyepieces and camera will see a different FOV due to a difference in magnification in each path. Please see the *Magnification & FOV* tab for more information on objective's magnification dependence on the system's tube lens and how paths with differing magnifications will see a different FOV.

- The LAURE1 and LAURE2 trinoculars are currently unavailable to ship due to supply chain issues. Newly placed orders will take at least six months to fulfill. Our order fulfillment team will confirm a shipment date once we have more clarity around when there will be sufficient inventory to fulfill new requests.

Part Number	Description	Price	Availability
LAURE1	Cerna Trinoculars with 10X Eyepieces, Upright Image, IR Filter	\$4,000.00	Lead Time
LAURE2	Cerna Trinoculars with 10X Eyepieces, Upright Image, No IR Filter	\$3,500.00	Lead Time
WFA4002	Trinoculars with 10X Eyepieces, Upright Image, IR Filter	\$4,000.00	7-10 Days

[Hide Camera Tubes](#)

Camera Tubes

- ▶ Positions Camera Sensor at Image Plane with 1X, 0.75X, 0.7X, or 0.5X Magnification
- ▶ Versions with Tube Lens Form an Image on a Camera Sensor
- ▶ Versions without Tube Lens Provide Optical Distance When Using Trinoculars or Double Camera Ports
- ▶ C-Mount (1.00"-32) Threads for Camera Attachment



Click to Enlarge
Fine Focus Adjuster (Item # SM1ZM) on Camera Tube (Available on Item #'s TC1X, WFA4100, WFA4101, and WFA4102)

These camera tubes provide the mechanical spacing necessary to align a camera sensor to the imaging plane in a microscopy system. The top of each camera tube has external C-Mount (1.00"-32) threading that accepts Thorlabs' scientific cameras, as well as cameras from most major manufacturers. In order to balance the size of the field of view (FOV) displayed on the camera against the resolution of the microscope, our camera tubes are offered in several magnifications from 1X to 0.5X. Greater magnification improves the resolution, but it also decreases the size of the FOV. Please see the *Magnification & FOV* tab for more information.

The WFA4100, WFA4101, and WFA4102 all include either a 200 mm, 150 mm, or 100 mm focal length tube lens, respectively, which allows them to be used in place of trinoculars for applications where the eyepieces are not needed. The tube lens and bottom-located male D1N dovetail make them compatible with the front port of the CSD1001 and CSD1002 double camera ports (available below), microscope bodies, or epi-illuminator modules. To compensate for mechanical tolerances or alignment issues, these camera tubes also include an SM1ZM Fine Focus Adjuster directly before the camera, shown in the photo to the right.

In contrast, the other camera tubes available here do not have built-in tube lenses. They act as a spacer with or without magnification that positions the camera's CCD chip at the imaging plane when used with the compatible trinocular or double camera port. The lack of a tube lens and the bottom-located male D2N, D2NB, or D5N male dovetail make them compatible with the rear port of the CSD1002 double camera port (available below) or trinoculars (sold above). To compensate for small mechanical tolerances or alignment issues, three 5/64" (2 mm) hex setscrews on the side of the housing can be used to adjust the camera position.

Please see the table below for complete compatibility details and the *Microscope Dovetails* tab for more information on the dovetails used.

Specifications and Compatibility							
Item #	Magnification ^{a,b}	Dovetail	Included Tube Lens	Included Camera Focus Adjuster	Compatibility with Trinoculars	Compatibility with Double Camera Ports	Camera Threading
WFA4100	1X	Male D1N	Yes; f = 200 mm 	Yes (SM1ZM)	No ^c	CSD1001 and CSD1002 Front Port	C-Mount (1.00"-32)
WFA4101	0.75X		Yes; f = 150 mm (AC508-150-A)				
WFA4102	0.5X		Yes; f = 100 mm (AC300-100-A)				
WFA4112	1X	Male D2NB	No	No	No	CSD1002 Rear Port	
TC1X	1X	Male D2N	No	Yes (SM1ZM)	LAURE1 and LAURE2	No	
WFA4106	0.7X	Male D2N	No	No	WFA4000 ^d	No	

- The magnification values are calculated assuming a design tube lens focal length of 200 mm. See the *Magnification & FOV* tab for these calculations and a list of design tube lens focal lengths for different manufacturers.
- Greater magnification improves the resolution, but also decreases the size of the FOV. Please see the *Magnification & FOV* tab for more information about the attainable FOV.
- Aside from the mechanical incompatibility between the dovetail mounting features, the trinoculars above and WFA4100, WFA4101, and WFA4102 Camera Tubes each have a built-in 200 mm, 150 mm, or 100 mm focal length tube lens.
- This previous generation item is no longer available.

Part Number	Description	Price	Availability
WFA4100	1X Camera Tube with C-Mount, Male D1N Dovetail	\$1,093.64	Today
WFA4101	0.75X Camera Tube with C-Mount, Male D1N Dovetail	\$730.95	Today
WFA4102	0.5X Camera Tube with C-Mount, Male D1N Dovetail	\$525.71	Today
WFA4112	1X Camera Tube with C-Mount, Male D2NB Dovetail	\$328.89	Today
TC1X	1X Camera Tube for LAURE1 & LAURE2 Trinoculars, C-Mount, Male D2N Dovetail	\$411.54	Today
WFA4106	0.7X Camera Tube for WFA4000 Trinoculars, C-Mount, Male D2N Dovetail	\$992.38	Lead Time

[Hide Trinocular Eyepiece](#)

Trinocular Eyepiece



- ▶ Replacement Eyepiece for Cerna Trinoculars (Sold Above)
- ▶ 10X Magnification
- ▶ Field Number: 22 mm

The TE10X eyepiece is identical to the ones included in the LAURE1 and LAURE2 Cerna trinoculars. It offers 10X magnification and has a field number of 22. The eyepiece features an adjustable focus that allows users to rotate the housing while not rotating the optics inside. It can be used with reticles and attached to trinoculars by sliding the narrower, Ø1.18" end of the eyepiece into the eyepiece slot on the trinoculars. Three notches on the housing secure the eyepiece in place once installed.

Item #	TE10X
Microscope Connection	Ø1.18" Eyepiece Tube
Magnification	10X
Field Number	22
Length	2.05" (52.1 mm)

Part Number	Description	Price	Availability
TE10X	Cerna Microscope Eyepiece, 10X Magnification, Field Number 22	\$300.00	Today

[Hide IR Blocking Filter](#)

IR Blocking Filter

- ▶ IR Filter for Cerna Trinoculars (Sold Above)
- ▶ $OD_{avg} > 6$ in Rejection Region
- ▶ $T_{avg} > 90\%$ in Transmission Region
- ▶ 30 mm Outer Diameter

The TF1 IR blocking filter is identical to the one included in the LAURE1 Cerna trinoculars. It can be installed before the eyepieces in the LAURE2 trinoculars (sold above), which do not include a blocking filter, using an SM30RR retaining ring (not included); only one filter is needed for both eyepieces. The filter transmits light from 375 - 650 nm and blocks light from 700 - 1400 nm. It features a durable immersed dielectric coating on a Borofloat® substrate.

Note: Borofloat® is a registered trademark by a company of the Schott group.

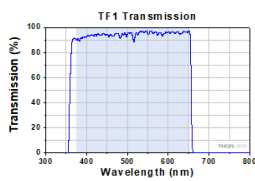

The TF1 filter provides >90% average transmission from 375 to 650 nm, denoted by the blue shaded region.

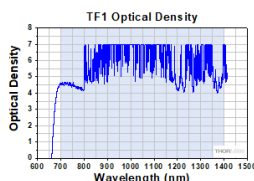

The TF1 filter has an average optical density of >6 from 700 to 1400 nm, denoted by the blue shaded region.

Item #	TF1
Transmission Region	375 - 650 nm $T_{avg} > 90\%$
Rejection Region	700 - 1400 nm $OD_{avg} > 6$
Construction	Immersed Dielectric
Surface Quality	80-50 Scratch-Dig
Substrate Material	Borofloat®
Diameter	30.0 mm (1.18")
Diameter Tolerance	±0.1 mm
Clear Aperture	Ø27 mm
Thickness	3.3 mm (0.13")

Part Number	Description	Price	Availability
TF1	Ø30 mm IR Blocking Filter, Transmission: 375 - 650 nm, Rejection: 700 - 1400 nm	\$615.00	Today

[Hide Trinocular Eyepiece Adapter](#)

Trinocular Eyepiece Adapter

- ▶ Replace Trinocular Eyepiece for DIY Construction
- ▶ Compatible with SM1, SM2, and 30 mm Cage Construction Systems



The SM2N2 Eyepiece Adapter allows custom-built optical detection systems to attach to either eyepiece on the trinoculars of a Cerna Microscope. This adapter replaces the lens element on the eyepiece that sets the image plane at the the back of the eyes (see image to the right). Five alignment slots ensure the adapter fits snugly inside the eyepiece without rotation; because of the drop-in nature of this adapter, take care the attached system does not overbalance the 40 g eyepiece adapter when it is inside the trinoculars.

This adapter features internal SM1 (1.035"-40) threading for Ø1" lens tubes; two SM1RR retaining rings are included to secure an optic inside the adapter. The adapter also has external SM2 (2.035"-40) threading for Ø2" lens tubes. The face with the item # engraving has 4-40 tapped holes for 30 mm cage systems.

Item #	SM2N2
Microscope Connection	Ø1.18" Eyepiece Tube (Alignment Slot, 5 Places)
SM Threading	Internal SM1 (1.035"-40) External SM2 (2.035"-40)
Cage Compatibility	30 mm Cage System (4-40 Tap, One Side, 4 Places)
Clear Aperture	Ø0.90" (22.9 mm)
Adapter Profile (Click for Drawing)	

Part Number	Description	Price	Availability
SM2N2	Nikon Eclipse or Cerna Microscope Eyepiece Adapter, Internal SM1 and External SM2 Threads, 30 mm Cage Compatibility	\$146.80	Today

[Hide Double Camera Ports with Built-In Optics](#)

Double Camera Ports with Built-In Optics

- ▶ Allows Two Cameras to be Simultaneously Attached to the Microscope
- ▶ CSD1002 Double Camera Port:
 - ▶ Fixed Magnification
 - ▶ All Light can Be Sent to the Front or Rear Port
- ▶ CSD1001 Double Camera Port:
 - ▶ Variable Magnification Using a Side-Located Knob
 - ▶ Light Can be Sent to Front Port or Split with Visible to Front and NIR to Rear

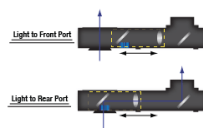

Click to Enlarge CSD1002 Operation Diagram

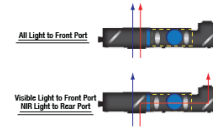

Click to Enlarge CSD1001 Operation Diagram

These Double Camera Ports let you simultaneously attach two cameras to a microscope system. The use of two separate cameras, which independently detect the signals from the sample, adds a significant amount of experimental flexibility.

The CSD1002 Double Camera Port provides fixed magnification for the front and rear cameras. As shown in the operation diagram to the right, this camera port contains an internal silver mirror that can be moved into the optical path to reflect all incoming light to the rear port.

In contrast, the CSD1001 Double Camera Port offers fixed magnification for the front camera and variable magnification of 0.35X, 2X, or 4X for the rear camera. The magnification is set by rotating a knob on the right side of the housing. As shown in the operation diagram to the right, it also contains an internal dichroic mirror that can be moved into the optic path to transmit visible light to the front port and reflect NIR light to the rear port. A graph showing the transmission and reflectance information can be found in the table below. The rear port also has a built-in NIR DIC analyzer that can be selectively added into the beam path using a side-located lever.

Camera Mounting

The front port of each double camera port contains a female D1N dovetail for mounting widefield assemblies used to view the FOV. As shown in the diagram above, there is no internal tube lens prior to the first port of either system. Therefore, any component mounted to this port requires a tube lens to resolve the image from the objective. To remain parfocal with the rear port, the focal length of the tube lens should be 200 mm. Solutions from Thorlabs' DIY Cerna components include any of the camera tubes with a built-in tube lens or our trinoculars (available above). For more information on how the tube lens focal length affects the system magnification, see the *Magnification & FOV* tab for details.



Click to Enlarge LAURE1 Trinoculars Attached to the Front Port of the CSD1001 Double Camera Port



In contrast to the front port, an internal tube lens is provided before the rear port of each double camera port. The rear port of the CSD1002 has a D2NB dovetail to attach the WFA4112 1X camera tube (available above). This camera tube is designed to mechanically align a mounted camera with the image plane provided by the internal tube lens and contains no internal optics. The rear port for the CSD1001 contains an externally threaded C-Mount (1.00"-32) for direct

attachment of a scientific camera that will be parfocal with a camera mounted to the front port (assuming a 200 mm tube lens was used).

Item #	CSD1002		CSD1001
Top Connection Interface	Front Port	Female D1N	Female D1N
	Rear Port	Female D2NB ^a	Externally Threaded C-Mount (1.00"-32) ^b
Bottom Connection Interface	Male D1N		Male D1N
Location of Internal Tube Lens	Before Rear Port ^a		Before Rear Port ^b
Reflector for Rear Port	Silver Mirror ^c		Dichroic Mirror
Mechanical Drawing (Click for Details)			

- a. The WFA4112 1X Camera Tube is required to align a mounted camera at the image plane set by the internal tube lens.
- b. Image plane is located at the flange focal distance of the included C-Mount (1.00"-32) thread on the rear port. No additional components are needed to align a camera to this image plane.
- c. The CSD1002 has an internal silver mirror that can redirect all of the incoming light to the rear port.

Part Number	Description	Price	Availability
CSD1002	Fixed Magnification Double Camera Port	\$2,524.18	Today
CSD1001	Variable Magnification Double Camera Port	\$10,689.61	Lead Time

[Hide Double Camera Port Without Optics](#)

Double Camera Port Without Optics

- ▶ Microscope Adapters Allow Two Scientific Cameras to Image a Single Optical Input Simultaneously
- ▶ Optics Not Included:
 - ▶ Accepts 25 mm x 36 mm Dichroic Filters or Beamsplitters
 - ▶ Accepts Standard Ø25 mm or Ø1" Filters on Outputs
- ▶ Fine Pitch Rotation and XY Adjustment for Image Co-Registration
- ▶ Coarse Focus Adjustment for Parfocalization of Cameras
- ▶ Mechanically Adapt to Most Cerna, Olympus, and Nikon Upright Microscopes Using Thorlabs' Standard SM1 Interface (Microscope Camera Port Adapters Sold Separately)

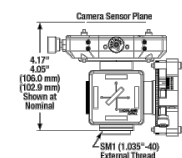

Click for Details
Mechanical Diagram of the 2CM1 Double Camera Port

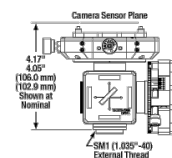

Click for Details
Mechanical Diagram of the 2CM2 Double Camera Port

Thorlabs' two-camera mounts are designed to attach two Thorlabs scientific cameras to a standard microscope, allowing simultaneous imaging of a single optical output. A rotation mount allows for 360° of rotational adjustment ($\pm 8^\circ$ fine adjustment) for the reflected camera while a translation mount gives 4 mm linear XY adjustment of the transmitted camera. Both camera mounts have coarse focus adjustment by manually translating the cameras, allowing for parfocalization of both images. The 2CM1 and 2CM2 mounts have up to 15 mm and 11 mm of adjustment, respectively, using the cage rods, although this adjustment range may be limited by the geometry of the camera's front face.

Each mount includes our fluorescence filter cube, which is designed to hold a fluorescence filter set (dichroic mirror, excitation filter, and emission filter) as well as plate beamsplitters or other similarly sized optics. See the table to the right for compatible optic sizes. The filter cube has an insert to hold filter set components with a kinematic design for easy swapping between mounted filter sets without requiring realignment. A DFM1T1 filter cube insert for mounting additional filter sets is sold separately below. Please note that these mounts do not include tube lenses.

These camera ports are ideal for use with Thorlabs' scientific cameras and ThorCam software. The 2CM1 mount is designed for cameras with 60 mm cage system taps on the front, such as our scientific CCD cameras, while the 2CM2 mount is identical except for the inclusion of two LCP4S cage size adapters for compatibility with 30 mm cage system taps, such as those found on our compact scientific cameras with sCMOS and CMOS sensors. The ThorCam user interface, provided for free with our scientific cameras, includes a plug-in to allow for multiple live camera images to be overlaid into a real-time 2-channel composite, eliminating the need for frequent updates of a static overlay image. This live imaging method is ideal for applications such as calcium ratio imaging and electrophysiology.

To see example applications where these camera ports are used and how various filters and dichroics are used, please see the full presentation. For double camera ports with an internal tube lens please see the CSD1001 and CSD1002 above.

Microscope Compatibility

The input port of each camera port adapter has external SM1 (1.035"-40) threading and places Thorlabs scientific cameras' sensors at a distance of 4.05" to 4.17" (102.9 mm to 106.0 mm) from the base of the mount (see drawings to the upper right), which may be outside the parfocal distance of some microscopes. See the compatibility information below for details.

Thorlabs' Cerna Microscope Systems

These camera ports can be mounted directly onto our previous-generation inverted-image trinoculars using the SM1A58 adapter (available below). When used with the trinoculars, each mounted camera will be parfocal with the eyepieces. Alternatively, a custom camera tube assembly can also be made to support the two-camera mount. This can be done using the WFA4110 adapter and lens tube or cage system assemblies. When used with upright-image trinocs the camera sensors will not be parfocal with the eyepieces.

Other Commercial Microscopes

Thorlabs offers a line of microscope camera port adapters that will allow these two-camera mounts to be installed on many commercial microscopes. When used with inverted microscopes from Nikon and Olympus the camera sensor will be outside the parfocal distance of the microscope and therefore should only be used if parfocality with the eyepieces is not needed. These mounts will be parfocal with upright microscopes from Nikon and Olympus. For Olympus BX or IX microscopes, Thorlabs offers the SM1A51 camera port adapter with SM1 threading. For upright Nikon Eclipse microscopes, the two-camera mount can be attached to the trinocular's camera port using our SM1A58 camera port adapter.

Compatible Filters			
Type	Dimensions	Thickness	
Excitation	Ø25 mm	5 mm	
Emission	Ø25 mm	3.5 mm	
Dichroic	Min	25.0 mm x 35.6 mm	1.0 mm
	Max	25.2 mm x 36.0 mm	2.0 mm

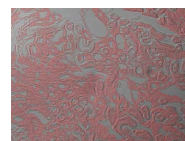

Click to Enlarge
Live two-channel composite image generated using 2CM1 Mount, scientific CCD cameras, and ThorCam software. The image shows Fluorescence (Pink) and DIC (Grayscale) images of a mouse kidney.

Part Number	Description	Price	Availability
2CM1	Two-Camera Mount for Microscopes, 60 mm Cage Mount Compatible	\$1,845.00	Today
2CM2	Two-Camera Mount for Microscopes, 30 mm Cage Mount Compatible	\$1,927.00	Today

[Hide Breadboard Tops for Microscope Bodies](#)

Breadboard Tops for Microscope Bodies

- ▶ Male D1N Dovetail on Bottom for Attachment to DIY Cerna Microscope Bodies
- ▶ Available in Two Sizes in Imperial and Metric Versions:
 - ▶ Imperial: 14.00" x 11.00" or 18.00" x 4.60"
 - ▶ Metric: 350.0 mm x 275.0 mm or 450.0 mm x 116.8 mm
- ▶ 1/4"-20 or M6 x 1.0 Mounting Holes



Click to Enlarge
Each breadboard has a male D1N dovetail on the bottom.

These black-anodized aluminum breadboard tops support user-designed widefield viewing apparatuses, epi-illumination pathways, and laser scanning pathways on top of upright Cerna microscopes. Each contains a Ø1.5" (Ø38.1 mm) through hole that is centered on a male D1N dovetail. This dovetail allows the breadboard to be connected directly to the epi-illumination arm of the microscope body, and it can also be used to stack the breadboard on top of an epi-illumination module. Additional details on the dovetail are available in the [Microscope Dovetails](#) tab.



Click for Details
CSA3010 Used to Mount a Custom Epi-Illuminator and Widefield Viewing Apparatus with a sCMOS Camera



Click for Details
CSA3000 Used to Mount a Custom Epi-Illuminator and Widefield Viewing Apparatus with a Previous-Generation CCD Camera

The breadboards are available in two sizes. The larger version [Item # CSA3000(M)] provides additional work surface, but protrudes past the sides of the epi-

illumination arm, which may restrict approach angles around the objective for micromanipulators. The smaller version [Item # CSA3010/(M)] does not restrict approach angles and also has eight 4-40 taps around the Ø1.5" through hole for 30 mm and 60 mm cage systems.

In configurations where the breadboard is mounted directly on top of the epi-illumination arm, four M4 counterbores can be used to provide additional mounting stability.

Item #	CSA3000	CSA3000/M	CSA3010	CSA3010/M
Dimensions (L x W)	14.00" x 11.00"	350.0 mm x 275.0 mm	18.00" x 4.60"	450.0 mm x 116.8 mm
Breadboard Thickness	1/2"	12.7 mm	1/2"	12.7 mm
Hole Size and Spacing	1/4"-20 Tapped Holes on 1" Centers	M6 x 1.0 Tapped Holes on 25 mm Centers	1/4"-20 Tapped Holes on 1" Centers	M6 x 1.0 Tapped Holes on 25 mm Centers
Number of Tapped Holes	154	154	87	89
Cage System Compatibility	-		Four 4-40 Taps for 30 mm Cage Systems Four 4-40 Taps for 60 mm Cage Systems	
Click for Mechanical Drawing	i	i	i	i
Dovetail	Male D1N			
Material	Matte Black Anodized Aluminum			

Part Number	Description	Price	Availability
CSA3000/M	Breadboard Top, 350.0 mm x 275.0 mm, M6 x 1.0 Taps, Male D1N Dovetail	\$755.76	Lead Time
CSA3010/M	Breadboard Top, 450.0 mm x 116.8 mm, M6 x 1.0 Taps, Male D1N Dovetail	\$918.87	7-10 Days
CSA3000	Breadboard Top, 14.00" x 11.00", 1/4"-20 Taps, Male D1N Dovetail	\$755.76	Lead Time
CSA3010	Breadboard Top, 18.00" x 4.60", 1/4"-20 Taps, Male D1N Dovetail	\$918.87	7-10 Days

[Hide Dovetail Adapters](#)

Dovetail Adapters

- ▶ Extend Versatility of Our Lens Tube and Cage Construction Systems to DIY Cerna Systems
- ▶ Compatible with DIY Cerna Modules that Have D1N, D2N, or D2NB Dovetails
- ▶ Male D1N to SM2 Adapter with Built-In TTL200 Tube Lens

These dovetail adapters integrate Thorlabs' Cerna microscopy platform with our SM1 (1.035"-40) lens tube, SM30 (M30.5 x 0.5) lens tube, SM2 (2.035"-40) lens tube, 30 mm cage, and 60 mm cage construction systems. They are ideal for creating custom widefield viewing, epi-illumination, and trans-illumination apparatuses. Additionally, we offer the LCPN3 trinocular port adapter, designed to allow Olympus trinoculars that have a male D5Y dovetail to be used with DIY Cerna systems.

See the table and images below for adapter features and application ideas. Please note the dovetail designations are specific to Thorlabs products; see the [Microscope Dovetails](#) tab for details.

Item #	WFA4111 ^a	WFA4110 ^a	CSA1003	LCPN2	LCPN3	SM1A58
Dovetail ^b	Male D1N	Male D1N	Female D1N	Male D1N	Male D1N Female D5Y	Male D2N Male D2NB
Threading	Internal M38 x 0.5 ^c External SM2	External SM2	No ^e	Internal SM30 ^d		Internal SM1 ^f External SM2
Cage Compatibility	No ^e	No ^e	60 mm Cage System (Ø6 mm Bore, 4 Places)	30 mm Cage System (4-40 Tap ^g , 4 Places) 60 mm Cage System (Ø6 mm Bore, 4 Places)	60 mm Cage System (Ø6 mm Bore, 4 Places)	30 mm Cage System (4-40 Tap, 4 Places)
Clear Aperture	Ø1.47" (37.0 mm)	-	Ø1.50" (38.1 mm)	Ø1.10" (27.9 mm)	Ø1.10" (27.9 mm)	Ø1.008" (25.6 mm)
Built-In Tube Lens	No	Yes (f = 200 mm)	No	No	No	No
Adapter Profile (Click for Drawing)	i	i	i	i	i	i

- Item #'s WFA4111 and WFA4110 have identical mechanical profiles, but Item # WFA4110 has a permanently installed TTL200 Tube Lens, which can be used to construct a custom camera tube.
- Additional information on dovetails is available in the [Microscope Dovetails](#) tab.
- This internal M38 x 0.5 threading is compatible with our SM38RR retaining rings.
- This internal SM30 threading is compatible with our SM30RR retaining rings. Two SM30RR retaining rings are included.
- An SM2-threaded cage plate can be used to convert between SM2 lens tubes and 60 mm cage systems.
- This internal SM1 threading is not deep enough for mounting optics.
- These tapped holes are on the side opposite the dovetail only.

Application Ideas



Click to Enlarge
Here, our WFA4111 D1N Adapter is being used to support an SM2

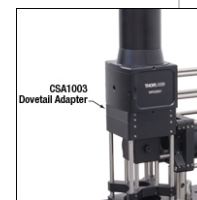

Click for Details

lens tube that contains user-selected optics for forming an image on a Scientific Camera.

Click to Enlarge
 In this photo, the WFA4110 D1N Adapter is being used to mount a user-designed camera tube made with an SM2 lens tube.

In this setup, the CSA1003 D1N Adapter is connecting lens tube and cage system components to a WFA2002 Epi-Illuminator Module.

Part Number	Description	Price	Availability
WFA4111	Adapter with Male D1N Dovetail, External SM2 Threads, and Internal M38 x 0.5 Threads	\$100.00	Today
WFA4110	Adapter with Male D1N Dovetail, External SM2 Threads, and TTL200 Tube Lens	\$634.44	7-10 Days
CSA1003	Adapter with Female D1N Dovetail and Bores for 60 mm Cage System	\$270.64	Lead Time
LCPN2	Nikon Eclipse or Cerna Microscope Trinocular Adapter, Male D1N Dovetail, Internal SM30 Threads, 30 and 60 mm Cage Compatibility	\$114.17	7-10 Days
LCPN3	Customer Inspired! Nikon Eclipse or Cerna Microscope Trinocular Adapter, Male D1N Dovetail, Female D5Y Dovetail, Internal SM30 Threads, 60 mm Cage Compatibility	\$107.54	Today
SM1A58	Upright Nikon Eclipse and Thorlabs Cerna Microscope Camera Port Adapter, Internal SM1 Threads, External SM2 Threads, 30 mm Cage Compatible	\$83.74	Today

Visit the *Widefield Viewing Modules for DIY Cerna® Systems* page for pricing and availability information:
https://www.thorlabs.com/newgrouppage9.cfm?objectgroup_id=8564

