

## LMM-40X-UVV-160 - June 17, 2021

Item # LMM-40X-UVV-160 was discontinued on June 17, 2021. For informational purposes, this is a copy of the website content at that time and is valid only for the stated product.

### REFLECTIVE MICROSCOPE OBJECTIVES

- ▶ Diffraction-Limited Performance and No Chromatic Aberration
- ▶ 15X, 25X, or 40X Magnification
- ▶ Infinity-Corrected or 160 mm Back Focal Length
- ▶ UV-Enhanced Aluminum and Protected Silver Coatings Available



**LMM-15X-P01**  
 450 nm - 20  $\mu$ m,  
 Infinite Back Focal Length



**LMM-25X-UVV-160**  
 200 nm - 20  $\mu$ m,  
 160 mm Back Focal Length



Each Finite Conjugate 40X Objective  
 Includes a Parfocal Length Extender  
 (LMM-40X-P01-160 Shown)

#### Application Idea

Reflective objective mounted in a CSN100 Cerna® Nosepiece with a PFM450E Piezo Objective Scanner

[Hide Overview](#)

#### OVERVIEW

##### Features

- 15X, 25X, or 40X Magnification (0.30 NA, 0.40 NA, or 0.50 NA, Respectively)
- Infinity-Corrected or 160 mm Back Focal Length
- Schwarzschild Design and Diffraction-Limited Performance
- All-Reflective Optical Design Introduces No Chromatic Aberration
- Two Broadband Reflective Coatings Available (See Plots to the Lower Right)
  - UV-Enhanced Aluminum:  $R_{\text{abs}} > 80\%$  for 200 nm - 20  $\mu$ m
  - Protected Silver:  $R_{\text{abs}} > 96\%$  for 450 nm - 20  $\mu$ m
- RMS (0.800"-36) Threads for Compatibility with Most Microscopes

##### Applications

- Fourier Transform Infrared (FTIR) Spectroscopy
- Semiconductor Wafer Inspection
- Photolithography
- Ellipsometric Thin Film Measurements
- Hyperspectral Imaging
- Thermal Imaging Microscopy
- UV Fluorescence Imaging
- Laser Scanning
- White Light Imaging
- Materials Processing
- Ultrafast Laser Pulses

##### Objective Lens Selection Guide

Objectives
Super Apochromatic Microscope Objectives
Microscopy Objectives, Dry
Microscopy Objectives, Oil Immersion
Physiology Objectives, Water Dipping or Immersion
Phase Contrast Objectives
Long Working Distance Objectives
Reflective Microscopy Objectives
UV Focusing Objectives
VIS and NIR Focusing Objectives
Scan Lenses and Tube Lenses
Scan Lenses
F-Theta Scan Lenses
Infinity-Corrected Tube Lenses

Thorlabs' Reflective Microscope Objectives consist of reflective surfaces that focus light without introducing chromatic aberration. We offer objectives with two broadband reflective coatings, three magnifications, and in either infinity-corrected or finite conjugate versions. Based on the classical Schwarzschild design, these objectives are corrected for third-order spherical aberration, coma, and astigmatism, and have negligible higher-order aberrations, resulting in diffraction-limited performance. Please refer to the *Wavefront Error* tab above for

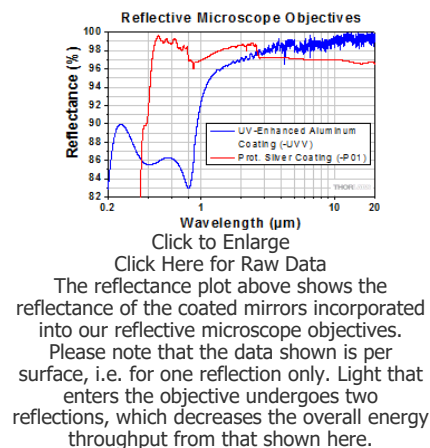

more details. These advantages make reflective objectives well suited for applications that require longer working distances than those provided by typical refractive objectives.

These objectives are available with one of two reflective coatings: a UV-enhanced aluminum coating for >80% absolute reflectance in the 200 nm - 20 µm wavelength range or a protected silver coating for >96% absolute reflectance in the 450 nm - 20 µm wavelength range. Note that this reflectance is for a single coated surface and incoming light is reflected by two coated surfaces. Refer to the tables below for additional specifications.

These objectives are RMS threaded (0.800"-36) for compatibility with most manufacturers' microscopes. As shown in the images above, the housings are engraved with the part number for easy identification. Additionally, Thorlabs also offers the M32RMSS thread adapter to convert RMS threads to M32 x 0.75 threads.

Each reflective objective incorporates a small convex secondary mirror that is mounted on three spider vanes. Also referred to as legs, these are visible at the tip of the objective in the middle photos below. Every reflective objective has three straight spider vanes except for LMM40X-UVV which has three 3-dimensional curved spider vanes. Please note that this mirror and the spider vanes act as a central obscuration (blocked area; refer to the images below) that causes a reduction of the contrast for low to mid spatial frequencies. The spider vanes also cause a faint diffraction pattern. Compared to straight spider vanes, the 3-dimensional curved spider vanes minimize the diffraction patterns and keep the obscuration ratio at a minimum. For custom objectives with curved spider vanes, please contact Tech Support. Please refer to the *Obscuration* tab for more information. Alternatively, our Zemax files can provide more details on the effect of the obscuration.

For custom objectives intended for vacuum or low-temperature applications, as well as non-magnetic versions of our reflective objectives, please contact Tech Support.

### Cleaning and Storage

To clean these objectives, we recommend using an inert gas, such as nitrogen or argon, to blow away contaminants. Solvents and liquids should not be used. If inert gas is not sufficient, please contact Tech Support to inquire about returning the optic to Thorlabs for cleaning/testing. The 40X magnification objectives except for LMM40X-UVV include dust caps while the 15X, 25X, and LMM40X-UVV objectives are shipped inside a protective container, as shown in the photo below. When not in use, we recommend using the included dust caps or clear case to protect the objective. For replacement or substitution, an objective case (OC2RMS lid and OC22 canister) and aluminum cap (RMSCP1) are also available for purchase separately.



Click to Enlarge  
 15X, 25X, and LMM40X-UVV objectives are shipped inside a storage case composed of an OC22 Canister and OC2RMS Lid. Other 40X objectives shipped with protective caps, which may be substituted with the same storage case (sold separately).

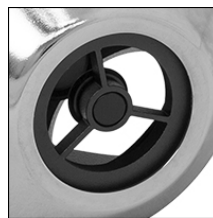

Click to Enlarge  
 The front-mounted convex mirror being held by three straight spider vanes.



Click to Enlarge  
 The front-mounted convex mirror being held by three 3D curved spider vanes.

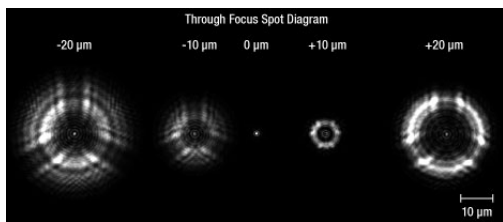

Click to Enlarge  
Reflective Objective with Three Straight Spider Vanes

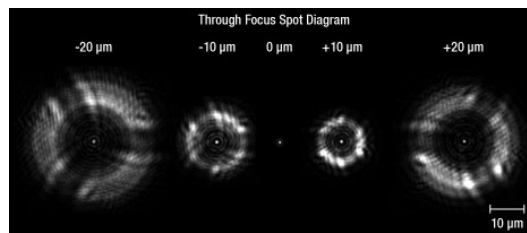

Click to Enlarge  
Reflective Objective with Three Curved Spider Vanes

The images above were taken with a reflective objective with straight (left) or curved (right) spider vanes at various offsets from the focal plane. When the spot is accurately focused (0 μm offset in the diagram above), the obscuration effect disappears within the central Airy disc and cannot be resolved any longer.

[Hide Wavefront Error](#)

## WAVEFRONT ERROR

### Diffraction-Limited and Minimal Spherical Aberration, Coma, and Astigmatism

The interferograms were determined with a 633 nm laser source. However, the peak-to-valley (P-V) and RMS wavefront error results are normalized to the output wavelength of 200 nm by a setting in the software. They measure the transmitted wavefront error of reflective objectives to quantitatively show the diffraction-limited design of these objectives. The extracted values in the tables below represent the performance of typical objectives. The interferograms also show these objectives correct 3rd order Seidel aberrations, such as astigmatism and coma.

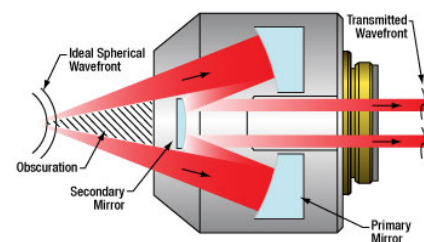

Click to Enlarge  
The wavefront is partially obscured by the secondary mirror and spider vanes before being reflected by the primary mirror and then the secondary mirror.

The intensity maps at the bottom right of each screenshot also show the obscured area in the center of the imaging system. The obscurations are caused by the convex mirror and the spider vane assembly holding the convex mirror in place.

Please note that the wavefront and aberration performance of these objectives is consistent regardless of the type of reflective coating, and thus the images and data below apply to the protected silver-coated (-P01) objectives as well as the UV-enhanced-aluminum-coated objectives (-UVV). The type of mirror coating primarily affects the light throughput at a given wavelength.

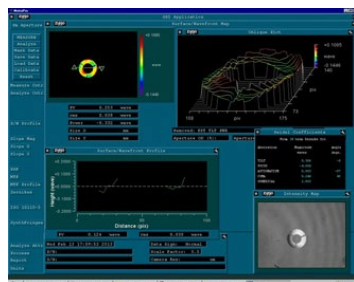

Click to Enlarge  
LMM-15X-UVV Interferogram with Measured Seidel Coefficients



Click to Enlarge  
LMM-25X-UVV Interferogram with Measured Seidel Coefficients

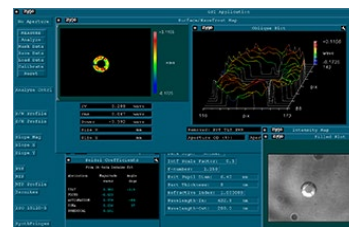

Click to Enlarge  
LMM40X-UVV Interferogram with Measured Seidel Coefficients

Sample LMM-15X-UVV Performance <sup>a</sup>	
	0.038λ (RMS)

Sample LMM-25X-UVV Performance <sup>a</sup>	
	0.049λ (RMS)

Transmitted Wavefront Error	0.253λ (P-V)
-----------------------------	--------------

Transmitted Wavefront Error	0.319λ (P-V)
-----------------------------	--------------

Sample LMM40X-UVV Performance <sup>a</sup>	
Transmitted Wavefront Error	0.047λ (RMS) 0.288λ (P-V)

a. All values are given in terms of λ, taking λ = 200 nm, which is the shortest wavelength supported by our UV-enhanced-aluminum-coated objectives. These values therefore correspond to the worst-case performance.

[Hide Obscuration](#)

## OBSCURATION

### Effects of Obscuration

Reflective objective designs incorporate a secondary mirror that is typically mounted on three spider vanes. The mirror and vanes create an obstruction to the entrance pupil (see Figures 1 and 2) that decreases transmitted light and modifies the diffraction pattern. Our Zemax files provide more detailed simulation data on the effects of the obscuration of our reflective objectives. Click on the red Document icon (📄) next to the item numbers below to access the Zemax file download. Our entire Zemax Catalog is also available.

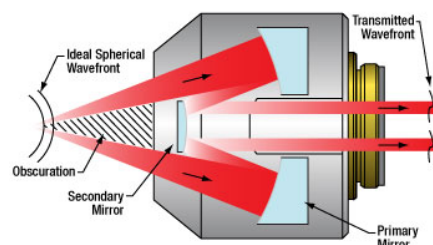

[Click to Enlarge](#)

**Figure 1:** The wavefront is partially obscured by the secondary mirror and spider vanes before being reflected by the primary mirror and then the secondary mirror.

### Central Obscuration

The central obscuration is caused by the convex secondary mirror (green mirrors in Figure 2 below) of the Schwarzschild objective. The value specified for the obscuration is the ratio of the obscured area to the entire area of the entrance pupil. If the entrance pupil is homogeneously filled, the transmitted light would be reduced by the same factor as the area obscuration. Furthermore, the central obscuration in the entrance pupil results in a redistribution of the intensities of the diffraction rings. Compared to the point spread function of an unobscured system, the central obscuration causes a slightly smaller diameter of the central Airy disc, and thus a slightly higher resolution. However, the secondary maxima also increase in intensity as illustrated in Figure 3 below.

The redistribution of the diffraction intensities also affects the contrast of the image, which is evident in the Modulation Transfer Functions (MTF) shown in Figure 4. Compared to an unobscured optical system, the MTF for low and mid spatial frequencies will decrease as the central obscuration increases in size. Also, the MTF increases slightly at high spatial frequencies, which correlates with the slightly smaller central Airy disc (see Figure 3).

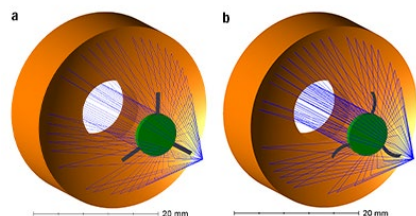

[Click to Enlarge](#)

**Figure 2:** This ray trace diagram illustrates the optics and obstructions in a reflective objective with three a) straight and b) curved spider vanes.

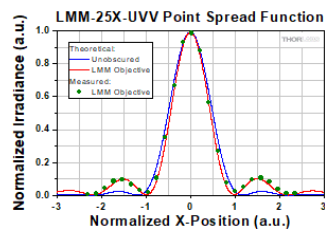

[Click to Enlarge](#)

**Figure 3:** This irradiance graph includes point spread functions and measured data of a gaussian beam through a reflective objective with 26% obscuration. The x-axis is the normalized distance from the theoretical maximum to the first minimum of the reflective objective.

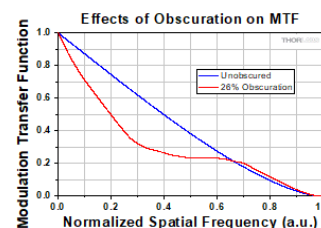

[Click to Enlarge](#)

**Figure 4:** Obscuration impacts the modulation transfer function (MTF) and image contrast. The theoretical MTF shown here is for a central circular obscuration with three spider vanes.

### Spider Vane Obscuration

Besides the central obscuration, the amount and distribution of the diffracted energy is dependent on the width, shape, and number of spider vanes used to

support the secondary mirror. The diffraction pattern in Figure 5 is produced by three straight spider vanes, like those illustrated in Figure 2a above. Please note that the plots are given with a logarithmic intensity scale over five orders of magnitude for a better visualization of the diffraction effects. Figure 6 shows a diffraction pattern produced by three curved spider vanes, like those illustrated in Figure 2b above. It can be seen that the amount of the diffracted energy will almost be the same, however, with a more even distribution. For comparison purposes, Figure 7 presents the pattern resulting from the use of four straight spider vanes. The objectives sold on this page incorporate three straight spider vanes except for the LMM40X-UVV reflective objective which incorporates three curved spider vanes. If this pattern is desirable for our other reflective objectives, they can be custom-ordered with curved vanes by contacting Tech Support.

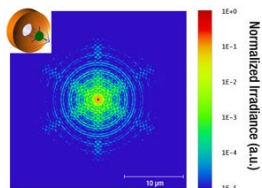

Click to Enlarge  
**Figure 5:** Diffraction Effect from Three Straight Spider Vanes

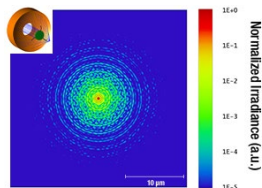

Click to Enlarge  
**Figure 6:** Diffraction Effect from Three Curved Spider Vanes

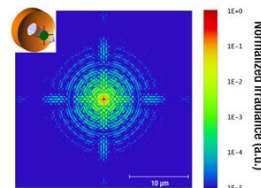

Click to Enlarge  
**Figure 7:** Diffraction Effect from Four Straight Spider Vanes

[Hide Objective Tutorial](#)

## OBJECTIVE TUTORIAL

### Objective Tutorial

This tutorial describes features and markings of objectives and what they tell users about an objective's performance.

### Objective Class and Aberration Correction

Objectives are commonly divided by their class. An objective's class creates a shorthand for users to know how the objective is corrected for imaging aberrations. There are two types of aberration corrections that are specified by objective class: field curvature and chromatic aberration.

Field curvature (or Petzval curvature) describes the case where an objective's plane of focus is a curved spherical surface. This aberration makes widefield imaging or laser scanning difficult, as the corners of an image will fall out of focus when focusing on the center. If an objective's class begins with "Plan", it will be corrected to have a flat plane of focus.

Images can also exhibit chromatic aberrations, where colors originating from one point are not focused to a single point. To strike a balance between an objective's performance and the complexity of its design, some objectives are corrected for these aberrations at a finite number of target wavelengths.

The four common objective classes are shown in the table to the right; only three are defined under the International Organization for Standards *ISO 19012-2: Microscopes -- Designation of Microscope Objectives -- Chromatic Correction*.

Chromatic Aberration Correction per ISO Standard 19012-2		
Objective Class	Common Abbreviations	Axial Focal Shift Tolerances <sup>a</sup>
Achromat	ACH, ACHRO, ACHROMAT	$ \delta_{C'} - \delta_{F'}  \leq 2 \times \delta_{ob}$
Semiapochromat (or Fluorite)	SEMIAPO, FL, FLU	$ \delta_{C'} - \delta_{F'}  \leq 2 \times \delta_{ob}$ $ \delta_{F'} - \delta_{e}  \leq 2.5 \times \delta_{ob}$ $ \delta_{C'} - \delta_{e}  \leq 2.5 \times \delta_{ob}$
Apochromat	APO	$ \delta_{C'} - \delta_{F'}  \leq 2 \times \delta_{ob}$ $ \delta_{F'} - \delta_{e}  \leq \delta_{ob}$ $ \delta_{C'} - \delta_{e}  \leq \delta_{ob}$
Super Apochromat	SAPO	See Footnote b

- Measured as the difference of the focal length ( $\delta$ ) between two of the following wavelengths: 479.99 nm (e-line), 546.07 nm (F'-line), and 643.85 nm (C'-line), compared to the theoretical focal length  $\delta_{ob}$ . The  $\delta_{ob} = (n \cdot \lambda_e) / (2 \cdot NA^2)$ , where  $n$  is the refractive index of the medium in object space,  $NA$  is the numerical aperture of the objective, and  $\lambda_e$  is 479.99 nm (e-line).
- Super apochromats currently are not defined under *ISO 19012-2: Microscopes -- Designation of Microscope Objectives -- Chromatic Correction*.

**Parts of a Microscope Objective**  
 Click on each label for more details.

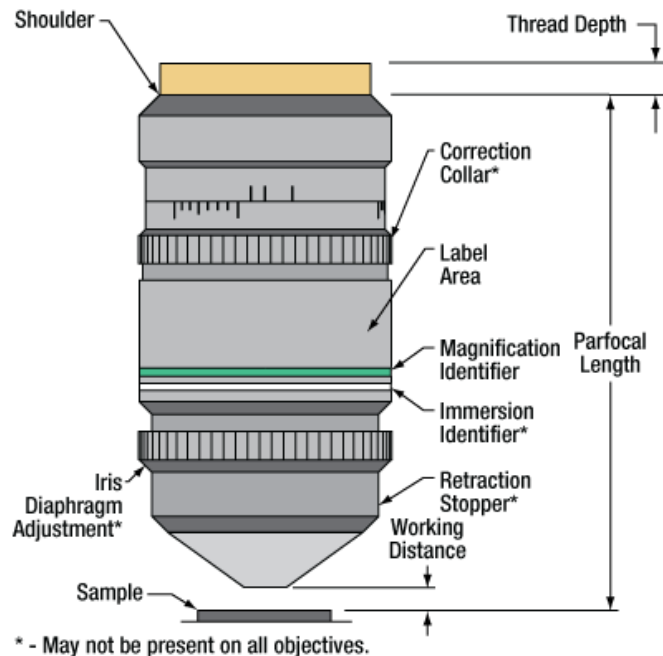

\* - May not be present on all objectives.

This microscope objective serves only as an example. The features noted above with an asterisk may not be present on all objectives; they may be added, relocated, or removed from objectives based on the part's needs and intended application space.

**Immersion Methods**  
Click on each image for more details.

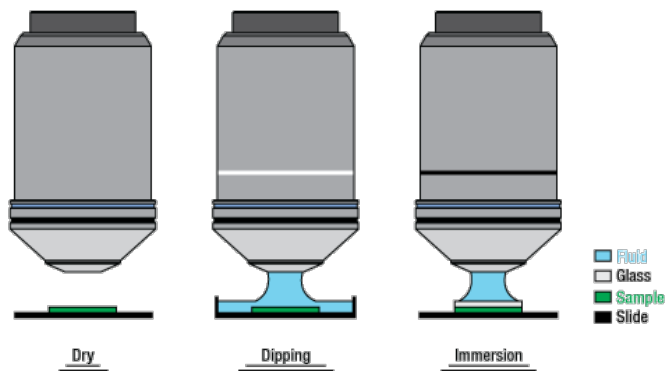

Objectives can be divided by what medium they are designed to image through. Dry objectives are used in air; whereas dipping and immersion objectives are designed to operate with a fluid between the objective and the front element of the sample.

**Glossary of Terms**

<p><b>Back Focal Length and Infinity Correction</b></p>	<p>The back focal length defines the location of the intermediate image plane. Most modern objectives will have this plane at infinity, known as infinity correction, and will signify this with an infinity symbol (<math>\infty</math>). Infinity-corrected objectives are designed to be used with a tube lens between the objective and eyepiece. Along with increasing interoperability between microscope systems, having this infinity-corrected space between the objective and tube lens allows for additional modules (like beamsplitters, filters, or parfocal length extenders) to be placed in the beam path.</p> <p>Note that older objectives and some specialty objectives may have been designed with finite back focal lengths. In their inception, finite back focal length objectives were meant to interface directly with the objective's eyepiece.</p>
<p><b>Entrance Aperture</b></p>	<p>This measurement corresponds to the appropriate beam diameter one should use to allow the objective to function properly.</p> <p><b>Entrance Aperture = <math>2 \times NA \times \text{Effective Focal Length}</math></b></p>
<p><b>Field Number and Field of View</b></p>	<p>The field number corresponds to the diameter of the field of view in object space (in millimeters) multiplied by the objective's magnification.</p>

Field Number = Field of View Diameter × Magnification	
<b>Magnification</b>	<p>The magnification (M) of an objective is the lens tube focal length (L) divided by the objective's effective focal length (F). Effective focal length is sometimes abbreviated EFL:</p> $M = L / EFL$ <p>The total magnification of the system is the magnification of the objective multiplied by the magnification of the eyepiece or camera tube. The specified magnification on the microscope objective housing is accurate as long as the objective is used with a compatible tube lens focal length. Objectives will have a colored ring around their body to signify their magnification. This is fairly consistent across manufacturers; see the <i>Parts of a Microscope</i> section for more details.</p>
<b>Numerical Aperture (NA)</b>	<p>Numerical aperture, a measure of the acceptance angle of an objective, is a dimensionless quantity. It is commonly expressed as:</p> $NA = n_i \times \sin\theta_a$ <p>where <math>\theta_a</math> is the maximum 1/2 acceptance angle of the objective, and <math>n_i</math> is the index of refraction of the immersion medium. This medium is typically air, but may also be water, oil, or other substances.</p>
<b>Working Distance</b>	<p>The working distance, often abbreviated WD, is the distance between the front element of the objective and the top of the specimen (in the case of objectives that are intended to be used without a cover glass) or top of the cover glass, depending on the design of the objective. The cover glass thickness specification engraved on the objective designates whether a cover glass should be used.</p>

Close

Threading allows an objective to be mounted to a nosepiece or turret. Objectives can have a number of different thread pitches; Thorlabs offers a selection of microscope thread adapters to facilitate mounting objectives in different systems.

Close

The shoulder is located at the base of the objective threading and marks the beginning of the exposed objective body when it is fully threaded into a nosepiece or other objective mount.

Close

A cover glass, or coverslip, is a small, thin sheet of glass that can be placed on a wet sample to create a flat surface to image across.

The most common, a standard #1.5 cover glass, is designed to be 0.17 mm thick. Due to variance in the manufacturing process the actual thickness may be different. The correction collar present on select objectives is used to compensate for cover glasses of different thickness by adjusting the relative position of internal optical elements. Note that many objectives do not have a variable cover glass correction, in which case the objectives have no correction collar. For example, an objective could be designed for use with only a #1.5 cover glass. This collar may also be located near the bottom of the objective, instead of the top as shown in the diagram.

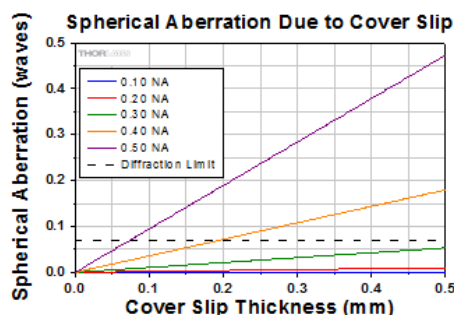

Close

Click to Enlarge

The graph above shows the magnitude of spherical aberration versus the thickness of the coverslip used for 632.8 nm light. For the typical coverslip thickness of 0.17 mm, the spherical aberration caused by the

coverslip does not exceed the diffraction-limited aberration for objectives with NA up to 0.40.

The labeling area for an objective usually falls in the middle of the objective body. The labeling found here is dictated by *ISO 8578: Microscopes -- Marking of Objectives and Eyepieces*, but not all manufacturers adhere strictly to this standard. Generally, one can expect to find the following information in this area:

- Branding/Manufacturer
- Aberration Correction (Objective Class)
- Magnification
- Numerical Aperture (NA)
- Back Focal Length (Infinity Correction)
- Suitable Cover Glass Thicknesses
- Working Distance

Additionally, the objective label area may include the objective's specified wavelength range, specialty features or design properties, and more. The exact location and size of each and any of these elements can vary.

Close

In order to facilitate fast identification, nearly all microscope objectives have a colored ring that circumscribes the body. A breakdown of what magnification each color signifies is given in the table below.

Magnification Identifier Color Ring Codes per ISO 8578			
<b>Black</b>	1X or 1.25X	<b>Light Green</b>	16X or 20X
<b>Grey</b>	1.6X or 2X	<b>Dark Green</b>	25X or 32X
<b>Brown</b>	2.5X or 3.2X	<b>Light Blue</b>	40X or 50X
<b>Red</b>	4X or 5X	<b>Dark Blue</b>	63X or 80X
<b>Orange</b>	6.3X or 8X	<b>White</b>	100X, 125X, or 160X
<b>Yellow</b>	10X or 12.5X		

Close

If an objective is used for water dipping, water immersion, or oil immersion, a second colored ring may be placed beneath the magnification identifier. If the objective is designed to be used with water, this ring will be white. If the objective is designed to be used with oil, this ring will be black. Dry objectives lack this identifier ring entirely. See the table to the right for a complete list of immersion identifiers.

Close

Immersion Identifier Color Ring Codes per ISO 8578	
<b>None</b>	Dry
<b>Black</b>	Oil
<b>White</b>	Water
<b>Orange</b>	Glycerol
<b>Red</b>	Others

Objectives that feature a built-in iris diaphragm are ideal for darkfield microscopy. The iris diaphragm is designed to be partially closed during darkfield microscopy in order to preserve the darkness of the background. This is absolutely necessary for high numerical aperture (above NA = 1.2) oil immersion objectives when using an oil immersion darkfield condenser. For ordinary brightfield observations, the iris diaphragm should be left fully open.

Close

Also referred to as the parfocal distance, this is the length from the shoulder to the top of the specimen (in the case of objectives that are intended to be used without a cover glass) or the top of the cover glass. When working with multiple objectives in a turret, it is helpful if all of the parfocal distances are identical, so little refocusing will be required when switching between objectives. Thorlabs offers parfocal length extenders for instances in which the parfocal length needs to be increased.



Close

The working distance, often abbreviated WD, is the distance between the front element of the objective and the top of the specimen (in the case of objectives that are intended to be used without a cover glass) or top of the cover glass. The cover glass thickness specification engraved on the objective designates whether a cover glass should be used.

Close

Objectives with very small working distances may have a retraction stopper incorporated into the tip. This is a spring-loaded section which compresses to limit the force of impact in the event of an unintended collision with the sample.

Close

Dry objectives are designed to have an air gap between the objective and the specimen.

Objectives following *ISO 8578: Microscopes -- Marking of Objectives and Eyepieces* will be labeled with an identifier ring to tell the user what immersion fluid the objective is designed to be used with; a list of ring colors can be found in the table to the right.

Close

Immersion Identifier Color Ring Codes per ISO 8578	
None	Dry
Black	Oil
White	Water
Orange	Glycerol
Red	Others

Dipping objectives are designed to correct for the aberrations introduced by the specimen being submerged in an immersion fluid. The tip of the objective is either dipped or entirely submerged into the fluid.

Objectives following *ISO 8578: Microscopes -- Marking of Objectives and Eyepieces* will be labeled with an identifier ring to tell the user what immersion fluid the objective is designed to be used with; a list of ring colors can be found in the table to the right.

Close

Immersion Identifier Color Ring Codes per ISO 8578	
None	Dry
Black	Oil
White	Water
Orange	Glycerol
Red	Others

Immersion objectives are similar to water-dipping objectives; however, in this case the sample is under a cover glass. A drop of fluid is then added to the top of the cover glass, and the tip of the objective is brought into contact with the fluid. Often, immersion objectives feature a correction collar to adjust for cover glasses with different thicknesses. Immersion fluids include water, oil (such as MOIL-30), and glycerol.

Using an immersion fluid with a high refractive index allows objectives to achieve numerical apertures greater than 1.0. However, if an immersion objective is used without the fluid present, the image quality will be very low. Objectives following *ISO 8578: Microscopes -- Marking of Objectives and Eyepieces* will be labeled with an identifier ring to tell the user what immersion fluid the objective is designed to be used with; a list of ring colors can be found in the table above.

Immersion Identifier Color Ring Codes per ISO 8578	
None	Dry
Black	Oil
White	Water
Orange	Glycerol
Red	Others

[Hide Magnification & FOV](#)

## Magnification and Sample Area Calculations

### Magnification

The magnification of a system is the multiplicative product of the magnification of each optical element in the system. Optical elements that produce magnification include objectives, camera tubes, and trinocular eyepieces, as shown in the drawing to the right. It is important to note that the magnification quoted in these products' specifications is usually only valid when all optical elements are made by the same manufacturer. If this is not the case, then the magnification of the system can still be calculated, but an effective objective magnification should be calculated first, as described below.

To adapt the examples shown here to your own microscope, please use our Magnification and FOV Calculator, which is available for download by clicking on the red button above. Note the calculator is an Excel spreadsheet that uses macros. In order to use the calculator, macros must be enabled. To enable macros, click the "Enable Content" button in the yellow message bar upon opening the file.

#### Example 1: Camera Magnification

When imaging a sample with a camera, the image is magnified by the objective and the camera tube. If using a 20X Nikon objective and a 0.75X Nikon camera tube, then the image at the camera has  $20X \times 0.75X = 15X$  magnification.

#### Example 2: Trinocular Magnification

When imaging a sample through trinoculars, the image is magnified by the objective and the eyepieces in the trinoculars. If using a 20X Nikon objective and Nikon trinoculars with 10X eyepieces, then the image at the eyepieces has  $20X \times 10X = 200X$  magnification. Note that the image at the eyepieces does not pass through the camera tube, as shown by the drawing to the right.

### Using an Objective with a Microscope from a Different Manufacturer

Magnification is not a fundamental value: it is a derived value, calculated by assuming a specific tube lens focal length. Each microscope manufacturer has adopted a different focal length for their tube lens, as shown by the table to the right. Hence, when combining optical elements from different manufacturers, it is necessary to calculate an *effective* magnification for the objective, which is then used to calculate the magnification of the system.

The effective magnification of an objective is given by Equation 1:

$$\text{Effective Objective Magnification} = \text{Design Magnification} \times \frac{f_{\text{Tube Lens in Microscope}} \text{ (mm)}}{f_{\text{Design Tube Lens of Objective}} \text{ (mm)}} \quad (\text{Eq. 1})$$

Here, the Design Magnification is the magnification printed on the objective,  $f_{\text{Tube Lens in Microscope}}$  is the focal length of the tube lens in the microscope you are using, and  $f_{\text{Design Tube Lens of Objective}}$  is the tube lens focal length that the objective manufacturer used to calculate the Design Magnification. These focal lengths are given by the table to the right.

Note that Leica, Mitutoyo, Nikon, and Thorlabs use the same tube lens focal length; if combining elements from any of these manufacturers, no conversion is needed. Once the effective objective magnification is calculated, the magnification of the system can be calculated as before.

#### Example 3: Trinocular Magnification (Different Manufacturers)

When imaging a sample through trinoculars, the image is magnified by the objective and the eyepieces in the trinoculars. This example will use a 20X Olympus objective and Nikon trinoculars with 10X eyepieces.

Following Equation 1 and the table to the right, we calculate the effective magnification of an Olympus objective in a Nikon microscope:

$$\text{Effective Objective Magnification} = 20X \times \frac{200 \text{ mm}}{180 \text{ mm}} = 22.2X$$

The effective magnification of the Olympus objective is 22.2X and the trinoculars have 10X eyepieces, so the image at the eyepieces has  $22.2X \times 10X = 222X$  magnification.

### Sample Area When Imaged on a Camera

When imaging a sample with a camera, the dimensions of the sample area are determined by the dimensions of the camera sensor and the system magnification, as shown by Equation 2.

$$\text{Sample Area (mm} \times \text{mm)} = \frac{\text{Camera Sensor Width (mm)}}{\text{System Magnification}} \times \frac{\text{Camera Sensor Height (mm)}}{\text{System Magnification}} \quad (\text{Eq. 2})$$

Magnification and  
FOV Calculator

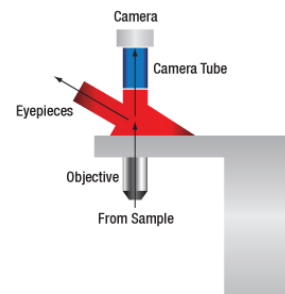

When viewing an image with a camera, the system magnification is the product of the objective and camera tube magnifications. When viewing an image with trinoculars, the system magnification is the product of the objective and eyepiece magnifications.

Manufacturer	Tube Lens Focal Length
Leica	f = 200 mm
Mitutoyo	f = 200 mm
Nikon	f = 200 mm
Olympus	f = 180 mm
Thorlabs	f = 200 mm
Zeiss	f = 165 mm

The rows highlighted in green denote manufacturers that do not use f = 200 mm tube lenses.

Sample Area When Imaged on a Camera

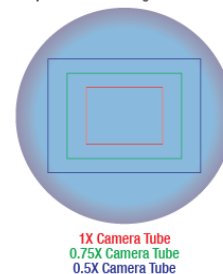

The camera sensor dimensions can be obtained from the manufacturer, while the system magnification is the multiplicative product of the objective magnification and the camera tube magnification (see Example 1). If needed, the objective magnification can be adjusted as shown in Example 3.

As the magnification increases, the resolution improves, but the field of view also decreases. The dependence of the field of view on magnification is shown in the schematic to the right.

**Example 4: Sample Area**

The dimensions of the camera sensor in Thorlabs' 1501M-USB Scientific Camera are 8.98 mm × 6.71 mm. If this camera is used with the Nikon objective and trinoculars from Example 1, which have a system magnification of 15X, then the image area is:

$$\text{Sample Area (mm} \times \text{mm)} = \frac{8.98 \text{ mm}}{15X} \times \frac{6.71 \text{ mm}}{15X} = 599 \mu\text{m} \times 447 \mu\text{m}$$

**Sample Area Examples**

The images of a mouse kidney below were all acquired using the same objective and the same camera. However, the camera tubes used were different. Read from left to right, they demonstrate that decreasing the camera tube magnification enlarges the field of view at the expense of the size of the details in the image.

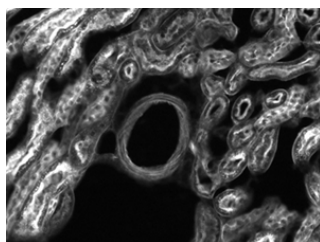

Click to Enlarge  
Acquired with 1X Camera Tube (Item # WFA4100)

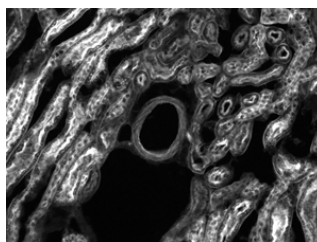

Click to Enlarge  
Acquired with 0.75X Camera Tube (Item # WFA4101)

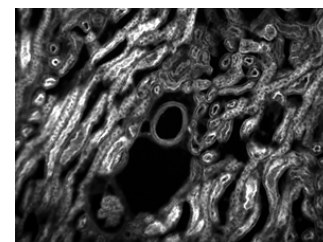

Click to Enlarge  
Acquired with 0.5X Camera Tube (Item # WFA4102)

[Hide Damage Thresholds](#)

DAMAGE THRESHOLDS

**Damage Threshold Data for Thorlabs' Reflective Objectives**

The specifications to the right are measured data for the mirrors used in Thorlabs' reflective microscope objectives. Damage threshold specifications are constant for all objectives with a given coating type, regardless of magnification or other specs.

Damage Threshold Specifications		
Coating Type	Laser Type	Damage Threshold
UV-Enhanced Aluminum (-UVV)	Pulsed	0.3 J/cm <sup>2</sup> (355 nm, 10 ns, 10 Hz, Ø0.381 mm)
Protected Silver (-P01)	Pulsed	1 J/cm <sup>2</sup> (1064 nm, 10 ns, 10 Hz, Ø0.230 mm)

**Laser Induced Damage Threshold Tutorial**

The following is a general overview of how laser induced damage thresholds are measured and how the values may be utilized in determining the appropriateness of an optic for a given application. When choosing optics, it is important to understand the Laser Induced Damage Threshold (LIDT) of the optics being used. The LIDT for an optic greatly depends on the type of laser you are using. Continuous wave (CW) lasers typically cause damage from thermal effects (absorption either in the coating or in the substrate). Pulsed lasers, on the other hand, often strip electrons from the lattice structure of an optic before causing thermal damage. Note that the guideline presented here assumes room temperature operation and optics in new condition (i.e., within scratch-dig spec, surface free of contamination, etc.). Because dust or other particles on the surface of an optic can cause damage at lower thresholds, we recommend keeping surfaces clean and free of debris. For more information on cleaning optics, please see our *Optics Cleaning* tutorial.

**Testing Method**

Thorlabs' LIDT testing is done in compliance with ISO/DIS 11254 and ISO 21254 specifications.

First, a low-power/energy beam is directed to the optic under test. The optic is exposed in 10 locations to this laser beam for 30 seconds (CW) or for a number of pulses (pulse repetition frequency specified). After exposure, the optic is examined by a microscope (~100X magnification) for any visible damage. The number of locations that are damaged at a particular power/energy level is recorded. Next, the power/energy is either increased or decreased and the optic is exposed at 10 new locations. This process is repeated until damage is observed. The damage threshold is then assigned to be the highest power/energy that the optic can withstand without causing damage. A histogram such as that below represents the testing of one BB1-E02 mirror.



The photograph above is a protected aluminum-coated mirror after LIDT testing. In this particular test, it handled 0.43 J/cm<sup>2</sup> (1064 nm, 10 ns pulse, 10 Hz, Ø1.000 mm) before damage.

According to the test, the damage threshold of the mirror was 2.00 J/cm<sup>2</sup> (532 nm, 10 ns pulse, 10 Hz, Ø0.803 mm). Please keep in mind that these tests are performed on clean optics, as dirt and contamination can significantly lower the damage threshold of a component. While the test results are only representative of one coating run, Thorlabs specifies damage threshold values that account for coating variances.

### Continuous Wave and Long-Pulse Lasers

When an optic is damaged by a continuous wave (CW) laser, it is usually due to the melting of the surface as a result of absorbing the laser's energy or damage to the optical coating (antireflection) [1]. Pulsed lasers with pulse lengths longer than 1 μs can be treated as CW lasers for LIDT discussions.

When pulse lengths are between 1 ns and 1 μs, laser-induced damage can occur either because of absorption or a dielectric breakdown (therefore, a user must check both CW and pulsed LIDT). Absorption is either due to an intrinsic property of the optic or due to surface irregularities; thus LIDT values are only valid for optics meeting or exceeding the surface quality specifications given by a manufacturer. While many optics can handle high power CW lasers, cemented (e.g., achromatic doublets) or highly absorptive (e.g., ND filters) optics tend to have lower CW damage thresholds. These lower thresholds are due to absorption or scattering in the cement or metal coating.

Pulsed lasers with high pulse repetition frequencies (PRF) may behave similarly to CW beams. Unfortunately, this is highly dependent on factors such as absorption and thermal diffusivity, so there is no reliable method for determining when a high PRF laser will damage an optic due to thermal effects. For beams with a high PRF both the average and peak powers must be compared to the equivalent CW power. Additionally, for highly transparent materials, there is little to no drop in the LIDT with increasing PRF.

In order to use the specified CW damage threshold of an optic, it is necessary to know the following:

1. Wavelength of your laser
2. Beam diameter of your beam (1/e<sup>2</sup>)
3. Approximate intensity profile of your beam (e.g., Gaussian)
4. Linear power density of your beam (total power divided by 1/e<sup>2</sup> beam diameter)

Thorlabs expresses LIDT for CW lasers as a linear power density measured in W/cm. In this regime, the LIDT given as a linear power density can be applied to any beam diameter; one does not need to compute an adjusted LIDT to adjust for changes in spot size, as demonstrated by the graph to the right. Average linear power density can be calculated using the equation below.

Example Exposure Histogram

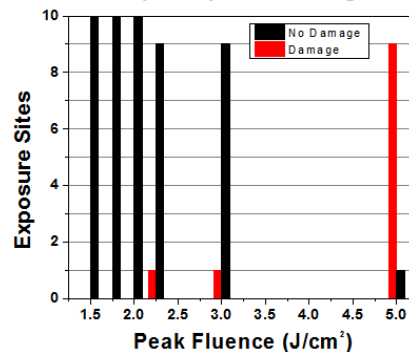

Example Test Data

Fluence	# of Tested Locations	Locations with Damage	Locations Without Damage
1.50 J/cm <sup>2</sup>	10	0	10
1.75 J/cm <sup>2</sup>	10	0	10
2.00 J/cm <sup>2</sup>	10	0	10
2.25 J/cm <sup>2</sup>	10	1	9
3.00 J/cm <sup>2</sup>	10	1	9
5.00 J/cm <sup>2</sup>	10	9	1

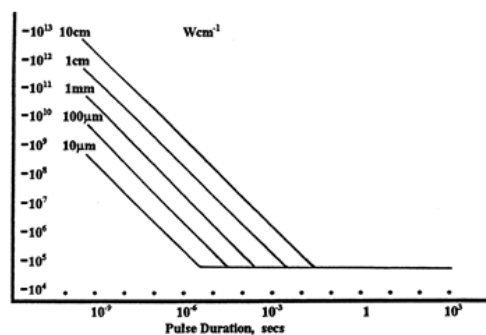

LIDT in linear power density vs. pulse length and spot size. For long pulses to CW, linear power density becomes a constant with spot size. This graph was obtained from [1].

$$\text{Linear Power Density} = \frac{\text{Power}}{\text{Beam Diameter}}$$

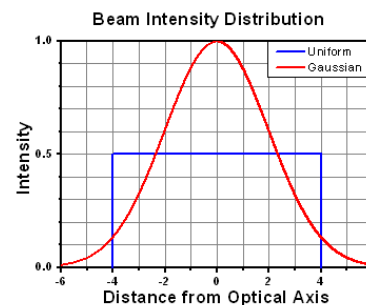

The calculation above assumes a uniform beam intensity profile. You must now consider hotspots in the beam or other non-uniform intensity profiles and roughly calculate a maximum power density. For reference, a Gaussian beam typically has a maximum power density that is twice that of the uniform beam (see lower right).

Now compare the maximum power density to that which is specified as the LIDT for the optic. If the optic was tested at a wavelength other than your operating wavelength, the damage threshold must be scaled appropriately. A good rule of thumb is that the damage threshold has a linear relationship with wavelength such that as you move to shorter wavelengths, the damage threshold decreases (i.e., a LIDT of 10 W/cm at 1310 nm scales to 5 W/cm at 655 nm):

$$\text{Adjusted LIDT} = \text{LIDT Power} \left( \frac{\text{Your Wavelength}}{\text{LIDT Wavelength}} \right)$$

While this rule of thumb provides a general trend, it is not a quantitative analysis of LIDT vs wavelength. In CW applications, for instance, damage scales more strongly with absorption in the coating and substrate, which does not necessarily scale well with wavelength. While the above procedure provides a good rule of thumb for LIDT values, please contact Tech Support if your wavelength is different from the specified LIDT wavelength. If your power density is less than the adjusted LIDT of the optic, then the optic should work for your application.

Please note that we have a buffer built in between the specified damage thresholds online and the tests which we have done, which accommodates variation between batches. Upon request, we can provide individual test information and a testing certificate. The damage analysis will be carried out on a similar optic (customer's optic will not be damaged). Testing may result in additional costs or lead times. Contact Tech Support for more information.

## Pulsed Lasers

As previously stated, pulsed lasers typically induce a different type of damage to the optic than CW lasers. Pulsed lasers often do not heat the optic enough to damage it; instead, pulsed lasers produce strong electric fields capable of inducing dielectric breakdown in the material. Unfortunately, it can be very difficult to compare the LIDT specification of an optic to your laser. There are multiple regimes in which a pulsed laser can damage an optic and this is based on the laser's pulse length. The highlighted columns in the table below outline the relevant pulse lengths for our specified LIDT values.

Pulses shorter than  $10^{-9}$  s cannot be compared to our specified LIDT values with much reliability. In this ultra-short-pulse regime various mechanics, such as multiphoton-avalanche ionization, take over as the predominate damage mechanism [2]. In contrast, pulses between  $10^{-7}$  s and  $10^{-4}$  s may cause damage to an optic either because of dielectric breakdown or thermal effects. This means that both CW and pulsed damage thresholds must be compared to the laser beam to determine whether the optic is suitable for your application.

Pulse Duration	$t < 10^{-9}$ s	$10^{-9} < t < 10^{-7}$ s	$10^{-7} < t < 10^{-4}$ s	$t > 10^{-4}$ s
Damage Mechanism	Avalanche Ionization	Dielectric Breakdown	Dielectric Breakdown or Thermal	Thermal
Relevant Damage Specification	No Comparison (See Above)	Pulsed	Pulsed and CW	CW

When comparing an LIDT specified for a pulsed laser to your laser, it is essential to know the following:

1. Wavelength of your laser
2. Energy density of your beam (total energy divided by  $1/e^2$  area)
3. Pulse length of your laser
4. Pulse repetition frequency (prf) of your laser
5. Beam diameter of your laser ( $1/e^2$ )
6. Approximate intensity profile of your beam (e.g., Gaussian)

The energy density of your beam should be calculated in terms of J/cm<sup>2</sup>. The graph to the right shows why expressing the LIDT as an energy density provides the best metric for short pulse sources. In this regime, the LIDT given as an energy density can be applied to any beam diameter; one does not need to compute an adjusted LIDT to adjust for changes in spot size. This calculation assumes a uniform beam intensity

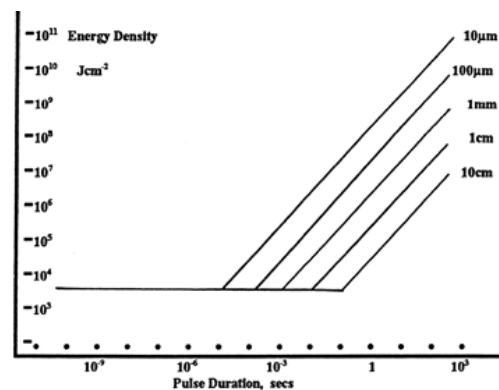

profile. You must now adjust this energy density to account for hotspots or other nonuniform intensity profiles and roughly calculate a maximum energy density. For reference a Gaussian beam typically has a maximum energy density that is twice that of the  $1/e^2$  beam.

Now compare the maximum energy density to that which is specified as the LIDT for the optic. If the optic was tested at a wavelength other than your operating wavelength, the damage threshold must be scaled appropriately [3]. A good rule of thumb is that the damage threshold has an inverse square root relationship with wavelength such that as you move to shorter wavelengths, the damage threshold decreases (i.e., a LIDT of 1 J/cm<sup>2</sup> at 1064 nm scales to 0.7 J/cm<sup>2</sup> at 532 nm):

$$\text{Adjusted LIDT} = \text{LIDT Energy} \sqrt{\frac{\text{Your Wavelength}}{\text{LIDT Wavelength}}}$$

You now have a wavelength-adjusted energy density, which you will use in the following step.

Beam diameter is also important to know when comparing damage thresholds. While the LIDT, when expressed in units of J/cm<sup>2</sup>, scales independently of spot size; large beam sizes are more likely to illuminate a larger number of defects which can lead to greater variances in the LIDT [4]. For data presented here, a <1 mm beam size was used to measure the LIDT. For beams sizes greater than 5 mm, the LIDT (J/cm<sup>2</sup>) will not scale independently of beam diameter due to the larger size beam exposing more defects.

The pulse length must now be compensated for. The longer the pulse duration, the more energy the optic can handle. For pulse widths between 1 - 100 ns, an approximation is as follows:

$$\text{Adjusted LIDT} = \text{LIDT Energy} \sqrt{\frac{\text{Your Pulse Length}}{\text{LIDT Pulse Length}}}$$

Use this formula to calculate the Adjusted LIDT for an optic based on your pulse length. If your maximum energy density is less than this adjusted LIDT maximum energy density, then the optic should be suitable for your application. Keep in mind that this calculation is only used for pulses between 10<sup>-9</sup> s and 10<sup>-7</sup> s. For pulses between 10<sup>-7</sup> s and 10<sup>-4</sup> s, the CW LIDT must also be checked before deeming the optic appropriate for your application.

Please note that we have a buffer built in between the specified damage thresholds online and the tests which we have done, which accommodates variation between batches. Upon request, we can provide individual test information and a testing certificate. Contact Tech Support for more information.

[1] R. M. Wood, *Optics and Laser Tech.* **29**, 517 (1998).

[2] Roger M. Wood, *Laser-Induced Damage of Optical Materials* (Institute of Physics Publishing, Philadelphia, PA, 2003).

[3] C. W. Carr *et al.*, *Phys. Rev. Lett.* **91**, 127402 (2003).

[4] N. Bloembergen, *Appl. Opt.* **12**, 661 (1973).

[Hide LIDT Calculations](#)

## LIDT CALCULATIONS

In order to illustrate the process of determining whether a given laser system will damage an optic, a number of example calculations of laser induced damage threshold are given below. For assistance with performing similar calculations, we provide a spreadsheet calculator that can be downloaded by clicking the button to the right. To use the calculator, enter the specified LIDT value of the optic under consideration and the relevant parameters of your laser

[LIDT Calculator](#)

system in the green boxes. The spreadsheet will then calculate a linear power density for CW and pulsed systems, as well as an energy density value for pulsed systems. These values are used to calculate adjusted, scaled LIDT values for the optics based on accepted scaling laws. This calculator assumes a Gaussian beam profile, so a correction factor must be introduced for other beam shapes (uniform, etc.). The LIDT scaling laws are determined from empirical relationships; their accuracy is not guaranteed. Remember that absorption by optics or coatings can significantly reduce LIDT in some spectral regions. These LIDT values are not valid for ultrashort pulses less than one nanosecond in duration.

#### CW Laser Example

Suppose that a CW laser system at 1319 nm produces a 0.5 W Gaussian beam that has a  $1/e^2$  diameter of 10 mm. A naive calculation of the average linear power density of this beam would yield a value of 0.5 W/cm, given by the total power divided by the beam diameter:

$$\text{Linear Power Density} = \frac{\text{Power}}{\text{Beam Diameter}}$$

However, the maximum power density of a Gaussian beam is about twice the maximum power density of a uniform beam, as shown in the graph to the right. Therefore, a more accurate determination of the maximum linear power density of the system is 1 W/cm.

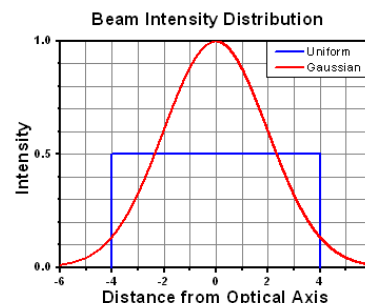

A Gaussian beam profile has about twice the maximum intensity of a uniform beam profile.

An AC127-030-C achromatic doublet lens has a specified CW LIDT of 350 W/cm, as tested at 1550 nm. CW damage threshold values typically scale directly with the wavelength of the laser source, so this yields an adjusted LIDT value:

$$\text{Adjusted LIDT} = \text{LIDT Power} \left( \frac{\text{Your Wavelength}}{\text{LIDT Wavelength}} \right)$$

The adjusted LIDT value of 350 W/cm x (1319 nm / 1550 nm) = 298 W/cm is significantly higher than the calculated maximum linear power density of the laser system, so it would be safe to use this doublet lens for this application.

#### Pulsed Nanosecond Laser Example: Scaling for Different Pulse Durations

Suppose that a pulsed Nd:YAG laser system is frequency tripled to produce a 10 Hz output, consisting of 2 ns output pulses at 355 nm, each with 1 J of energy, in a Gaussian beam with a 1.9 cm beam diameter ( $1/e^2$ ). The average energy density of each pulse is found by dividing the pulse energy by the beam area:

$$\text{Energy Density} = \frac{\text{Pulse Energy}}{\text{Beam Area}}$$

As described above, the maximum energy density of a Gaussian beam is about twice the average energy density. So, the maximum energy density of this beam is  $\sim 0.7 \text{ J/cm}^2$ .

The energy density of the beam can be compared to the LIDT values of  $1 \text{ J/cm}^2$  and  $3.5 \text{ J/cm}^2$  for a BB1-E01 broadband dielectric mirror and an NB1-K08 Nd:YAG laser line mirror, respectively. Both of these LIDT values, while measured at 355 nm, were determined with a 10 ns pulsed laser at 10 Hz. Therefore, an adjustment must be applied for the shorter pulse duration of the system under consideration. As described on the previous tab, LIDT values in the nanosecond pulse regime scale with the square root of the laser pulse duration:

$$\text{Adjusted LIDT} = \text{LIDT Energy} \sqrt{\frac{\text{Your Pulse Length}}{\text{LIDT Pulse Length}}}$$

This adjustment factor results in LIDT values of  $0.45 \text{ J/cm}^2$  for the BB1-E01 broadband mirror and  $1.6 \text{ J/cm}^2$  for the Nd:YAG laser line mirror, which are to be compared with the  $0.7 \text{ J/cm}^2$  maximum energy density of the beam. While the broadband mirror would likely be damaged by the laser, the more specialized laser line mirror is appropriate for use with this system.

#### Pulsed Nanosecond Laser Example: Scaling for Different Wavelengths

Suppose that a pulsed laser system emits 10 ns pulses at 2.5 Hz, each with 100 mJ of energy at 1064 nm in a 16 mm diameter beam ( $1/e^2$ ) that must be attenuated with a neutral density filter. For a Gaussian output, these specifications result in a maximum energy density of  $0.1 \text{ J/cm}^2$ . The damage threshold of an NDUV10A Ø25 mm, OD 1.0, reflective neutral density filter is  $0.05 \text{ J/cm}^2$  for 10 ns pulses at 355 nm, while the damage threshold of the similar NE10A absorptive filter is  $10 \text{ J/cm}^2$  for 10 ns pulses at 532 nm. As described on the previous tab, the LIDT value of an optic scales with the square root of the wavelength in the nanosecond pulse regime:

$$\text{Adjusted LIDT} = \text{LIDT Energy} \sqrt{\frac{\text{Your Wavelength}}{\text{LIDT Wavelength}}}$$

This scaling gives adjusted LIDT values of 0.08 J/cm<sup>2</sup> for the reflective filter and 14 J/cm<sup>2</sup> for the absorptive filter. In this case, the absorptive filter is the best choice in order to avoid optical damage.

#### Pulsed Microsecond Laser Example

Consider a laser system that produces 1 μs pulses, each containing 150 μJ of energy at a repetition rate of 50 kHz, resulting in a relatively high duty cycle of 5%. This system falls somewhere between the regimes of CW and pulsed laser induced damage, and could potentially damage an optic by mechanisms associated with either regime. As a result, both CW and pulsed LIDT values must be compared to the properties of the laser system to ensure safe operation.

If this relatively long-pulse laser emits a Gaussian 12.7 mm diameter beam (1/e<sup>2</sup>) at 980 nm, then the resulting output has a linear power density of 5.9 W/cm and an energy density of 1.2 x 10<sup>-4</sup> J/cm<sup>2</sup> per pulse. This can be compared to the LIDT values for a WPQ10E-980 polymer zero-order quarter-wave plate, which are 5 W/cm for CW radiation at 810 nm and 5 J/cm<sup>2</sup> for a 10 ns pulse at 810 nm. As before, the CW LIDT of the optic scales linearly with the laser wavelength, resulting in an adjusted CW value of 6 W/cm at 980 nm. On the other hand, the pulsed LIDT scales with the square root of the laser wavelength and the square root of the pulse duration, resulting in an adjusted value of 55 J/cm<sup>2</sup> for a 1 μs pulse at 980 nm. The pulsed LIDT of the optic is significantly greater than the energy density of the laser pulse, so individual pulses will not damage the wave plate. However, the large average linear power density of the laser system may cause thermal damage to the optic, much like a high-power CW beam.

[Hide Reflective Objectives, Infinity Corrected](#)

### Reflective Objectives, Infinity Corrected

- Reflective Objectives with 15X, 25X, or 40X Magnification
- Back Focal Length: Infinity
- UV-Enhanced Aluminum or Protected Silver Coatings
- RMS (0.800"-36) Objective Threading

These reflective objectives are designed with infinite back focal length and are ideal components of an infinity-corrected optical system in combination with our tube lenses. We offer three magnifications as well as two different reflective coatings (see table below for details). They are RMS threaded (0.800"-36) for compatibility with most manufacturers' microscopes.

Click on the red Document icon (  ) next to the item numbers below to access the Zemax file download. Our entire Zemax Catalog is also available.

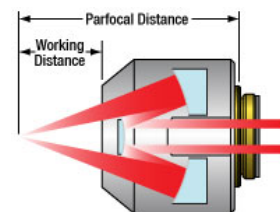

Click to Enlarge  
The diagram above illustrates the working distance and parafocal distance for reflective objectives with infinite back focal length.

Specifications						
Item #	LMM-15X-UVV	LMM-25X-UVV	LMM40X-UVV	LMM-15X-P01	LMM-25X-P01	LMM-40X-P01
Mirror Coating	UV-Enhanced Aluminum (R <sub>abs</sub> > 80% Over 200 nm - 20 μm)			Protected Silver (R <sub>abs</sub> > 96% Over 450 nm - 20 μm)		
Magnification <sup>a</sup>	15X	25X	40X	15X	25X	40X
Numerical Aperture	0.30	0.40	0.5	0.30	0.40	0.50
Focal Length	13.3 mm	8.0 mm	5.0 mm	13.3 mm	8.0 mm	5.0 mm
Parfocal Distance <sup>b</sup>	63.3 mm	45.0 mm	30.0 mm	63.3 mm	45.0 mm	30.0 mm
Back Focal Length	Infinity	Infinity	Infinity	Infinity	Infinity	Infinity
Design Tube Lens Focal Length <sup>c</sup>	200 mm	200 mm	200 mm	200 mm	200 mm	200 mm
Entrance Pupil Diameter <sup>d</sup>	8.0 mm	6.4 mm	5.1 mm	8.0 mm	6.4 mm	5.1 mm
Working Distance <sup>b</sup>	23.8 mm	12.5 mm	7.8 mm	23.8 mm	12.5 mm	7.8 mm
Field of View	1.2 mm	0.7 mm	0.5 mm	1.2 mm	0.7 mm	0.5 mm
Spider Vanes	Straight	Straight	Curved	Straight	Straight	Straight
Obscuration <sup>e</sup>	Secondary Mirror Only	22%	22%	18%	22%	18%
	Mirror and Spider Vanes	26%	26%	24%	26%	24%
Transmitted Wavefront Error	<λ/14 RMS at 200 nm			<λ/14 RMS at 450 nm		
Damage Threshold	Pulsed	2		2		



	0.3 J/cm (355 nm, 10 ns, 10 Hz, Ø0.381 mm)	1 J/cm (1064 nm, 10 ns, 10 Hz, Ø0.230 mm)
<b>Objective Threading</b>	0.800"-36 (RMS)	
<b>RMS Thread Depth</b>	4.7 mm	4.5 mm
	4.7 mm	4.7 mm
	4.5 mm	4.7 mm

- These values assume the use of a Tube Lens with  $f = 200$  mm.
- These quantities are defined by the drawing to the upper right.
- For information on compatibility between tube lenses and objectives, see the *Magnification & FOV* tab.
- Entrance pupil diameter is defined at the back aperture of the objective and may be approximated using  $EP=2*NA*EFL$ .
- The ratio of the obscured (blocked) area to the entire area of the entrance pupil. A ratio is given with and without the spider vanes.

Part Number	Description	Price	Availability
LMM-15X-UVV	15X Reflective Objective, UV-Enhanced Aluminum Coating, 0.30 NA, BFL = Infinity	\$2,212.93	Lead Time
LMM-25X-UVV	Customer Inspired! 25X Reflective Objective, UV-Enhanced Aluminum Coating, 0.40 NA, BFL = Infinity	\$2,217.53	Today
LMM40X-UVV	NEW! 40X Reflective Objective, UV-Enhanced Aluminum Coating, 0.5 NA, BFL = Infinity	\$2,445.59	Today
LMM-15X-P01	15X Reflective Objective, Protected Silver Coating, 0.30 NA, BFL = Infinity	\$2,202.11	Lead Time
LMM-25X-P01	25X Reflective Objective, Protected Silver Coating, 0.40 NA, BFL = Infinity	\$2,207.23	Today
LMM-40X-P01	40X Reflective Objective, Protected Silver Coating, 0.50 NA, BFL = Infinity	\$2,434.77	5-8 Days

[Hide Reflective Objectives, 160 mm Back Focal Length](#)

**Reflective Objectives, 160 mm Back Focal Length**

- Reflective Objectives with 15X, 25X, or 40X Magnification
- Back Focal Length: 160 mm
- UV-Enhanced Aluminum or Protected Silver Coatings
- RMS (0.800"-36) Objective Threading

These reflective objectives are designed with a finite back focal length of 160 mm and are ideal for imaging applications where no refractive optical elements are desired. We offer three magnifications as well as two different reflective coatings (see table below for details). They are RMS threaded (0.800"-36) for compatibility with most manufacturers' microscopes. The LMM-40X-UVV-160 and LMM-40X-P01-160 objectives are shipped with an attached PLE152 Parfocal Length Extender. This hollow extender increases the parfocal length to 45 mm to match other parfocal length standards, such as those used by Olympus and Leica.

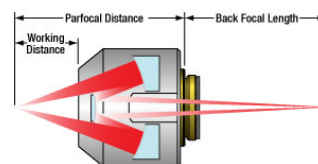

Click to Enlarge  
The diagram above illustrates the working distance, parfocal distance, and back focal length for reflective objectives with a finite back focal length.

Click on the red Document icon (  ) next to the item numbers below to access the Zemax file download. Our entire Zemax Catalog is also available.

Specifications						
Item #	LMM-15X-UVV-160	LMM-25X-UVV-160	LMM-40X-UVV-160	LMM-15X-P01-160	LMM-25X-P01-160	LMM-40X-P01-160
<b>Mirror Coating</b>	UV-Enhanced Aluminum ( $R_{abs} > 80\%$ Over 200 nm - 20 $\mu$ m)			Protected Silver ( $R_{abs} > 96\%$ Over 450 nm - 20 $\mu$ m)		
<b>Magnification</b>	15X	25X	40X	15X	25X	40X
<b>Numerical Aperture</b>	0.30	0.40	0.50	0.30	0.40	0.50
<b>Focal Length</b>	13.3 mm	8.0 mm	5.0 mm	13.3 mm	8.0 mm	5.0 mm
<b>Parfocal Distance<sup>a</sup></b>	63.3 mm	45.0 mm	45.0 mm <sup>b</sup>	63.3 mm	45.0 mm	45.0 mm <sup>b</sup>
<b>Back Focal Length<sup>a</sup></b>	160 mm	160 mm	160 mm <sup>b</sup>	160 mm	160 mm	160 mm <sup>b</sup>
<b>Entrance Pupil Diameter<sup>e</sup></b>	8.0 mm	6.4 mm	5.1 mm	8.0 mm	6.4 mm	5.1 mm
<b>Working Distance<sup>a</sup></b>	23.8 mm	12.5 mm	7.8 mm	23.8 mm	12.5 mm	7.8 mm
<b>Field of View</b>	1.2 mm	0.7 mm	0.5 mm	1.2 mm	0.7 mm	0.5 mm
<b>Spider Vanes</b>	Straight	Straight	Straight	Straight	Straight	Straight
<b>Obscuration<sup>d</sup></b>	<b>Secondary Mirror Only</b>	22%	22%	18%	22%	18%
	<b>Mirror and Spider Vanes</b>	26%	26%	24%	26%	24%
<b>Transmitted Wavefront Error</b>	< $\lambda/14$ RMS at 200 nm			< $\lambda/14$ RMS at 450 nm		
<b>Damage Threshold</b>	<b>Pulsed</b>	0.3 J/cm <sup>2</sup> (355 nm, 10 ns, 10 Hz, Ø0.381 mm)		1 J/cm <sup>2</sup> (1064 nm, 10 ns, 10 Hz, Ø0.230 mm)		

<b>Objective Threading</b>	0.800"-36 (RMS)					
<b>RMS Thread Depth</b>	4.7 mm	4.5 mm	4.7 mm	4.7 mm	4.5 mm	4.7 mm

- These quantities are defined by the drawing to the upper right.
- These values include the PLE152 Parfocal Length Extender that ships with the objective. Removing this extender reduces the parfocal length to 30.0 mm and increases the back focal length to 175 mm.
- Entrance pupil diameter (EP) is defined at the back aperture of the objective and may be approximated using  $EP=2*NA*EFL$ .
- The ratio of the obscured (blocked) area to the entire area of the entrance pupil. A ratio is given with and without the spider vanes.

<b>Part Number</b>	<b>Description</b>	<b>Price</b>	<b>Availability</b>
LMM-15X-UVV-160	15X Reflective Objective, UV-Enhanced Aluminum Coating, 0.30 NA, BFL = 160 mm	\$2,212.93	Today
LMM-25X-UVV-160	25X Reflective Objective, UV-Enhanced Aluminum Coating, 0.40 NA, BFL = 160 mm	\$2,217.53	Today
LMM-40X-UVV-160	40X Reflective Objective with Parfocal Extender, UV-Enhanced Aluminum Coating, 0.50 NA, BFL = 160 mm	\$2,525.66	Today
LMM-15X-P01-160	15X Reflective Objective, Protected Silver Coating, 0.30 NA, BFL = 160 mm	\$2,202.11	Today
LMM-25X-P01-160	25X Reflective Objective, Protected Silver Coating, 0.40 NA, BFL = 160 mm	\$2,207.23	5-8 Days
LMM-40X-P01-160	40X Reflective Objective with Parfocal Extender, Protected Silver Coating, 0.50 NA, BFL = 160 mm	\$2,514.84	Today