

**CPS850V - June 5, 2020**

Item # CPS850V was discontinued on June 5, 2020. For informational purposes, this is a copy of the website content at that time and is valid only for the stated product.

**COMPACT LASER MODULES WITH PHONO JACK**

- Wavelengths from 405 nm to 980 nm
- Collimated and Adjustable-Focus Versions
- Compact Ø8 mm or Ø11 mm Housing Options
- 850 nm Single-Wavelength Laser Module

**Application Idea**

Adjustable-Focus Laser Module Mounted in a KM100 Using an AD11NT Adapter



**CPS532**  
 Collimated Laser Module  
 Power Supply Not Included

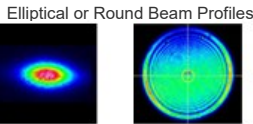

The CPS1 includes both a USB-to-Micro-USB cable and a custom USB-to-Phono cable.

[Hide Overview](#)

**OVERVIEW**

**Features**

- Collimated or Adjustable-Focus Laser Modules
- Compact Ø8 mm or Ø11 mm Housing Makes these Modules Ideal as Alignment Lasers
- Lasing at Wavelengths from 405 nm to 980 nm (See Table to the Right)
  - Four 635 nm Wavelength Options Provide Alternatives to HeNe Lasers
- Single-Wavelength VCSEL Collimated Laser Module for 850 nm Available
- Round or Elliptical Beam Profile Options
- Constant Power Mode Operation Using Built-In Photodiode Feedback
- Accessories to Power and Mount the Laser Modules Available Below

These phono-jack-equipped laser modules are available in either collimated or adjustable-focus varieties and provide output powers ranging from 0.85 mW to 4.5 mW (laser safety Class 2 or 3R depending on the model). Each module has an output beam shape that is either elliptical or round, as indicated in the tables below. These modules, which offer single-spatial-mode output and a compact cylindrical housing, are ideal for use as alignment lasers in optical systems.

For single-frequency applications, our collimated 850 nm VCSEL Module produces a single-wavelength output and a round, Gaussian beam shape similar to that of a point source. Its narrow linewidth produces a spectra that contains no sidebands, but this comes at the expense of a lower total power output.

All CPS laser modules are driven in constant-power mode, with feedback from an internal photodiode used to maintain the optical output power. As these products are not thermally stabilized, their optical output power may fluctuate slightly during operation.

**Power Supply Options**

Each module requires a 5 VDC power supply (not included) to operate. We offer the CPS1 External Battery Pack as well as the LDS5 Wall Adapter below. The CPS laser modules connect directly to the output of the LDS5 adapter, while the external battery pack requires the use of a USB-to-phono plug, which is included with each CPS1 battery pack.

Alternatively, a male 2.5 mm phono plug is included with each CPS laser module for customers who wish to wire their own power supply. These modules have either an 18" (457 mm) or 24" (610 mm) long cable with a female 2.5 mm phono socket for connection to a power supply.

Quick Links
<b>Laser Diode Modules</b>
405 nm - 532 nm
635 nm
650 nm - 780 nm
808 nm - 980 nm
850 nm VCSEL
<b>Accessories</b>
Mounting Adapters
Laser Module Kit
Kinematic Mount
5 VDC Power Supply
5 VDC Battery Pack



Click to Enlarge  
 CPS450 Laser Diode Module  
 Held in  
 a KAD11NT Unthreaded  
 Kinematic Adapter and  
 Mounted into an  
 FMP1 Fixed Optic Mount



Click to Enlarge  
 CPS980 Module Held in an  
 AD11F SM1-Threaded  
 Adapter and Mounted into  
 a CP44F Quick-Release  
 Cage Plate Within a 30 mm  
 Cage System



Click to Enlarge  
 CPS980S Laser Diode  
 Module Held in an  
 AD8F SM1-Threaded  
 Adapter and Mounted into  
 an LM1XY XY Translation  
 Mount





Click to Enlarge  
Portable 5 V Battery  
Pack Available

### Mounting Options

The Ø8 mm and Ø11 mm housings are compatible with our line of optomechanical components through the use of various mounting adapters, as shown in the images

above. Depending on the adapter chosen, these laser modules can be directly mounted into either internally SM1-threaded (1.035"-40) components or mechanics with a Ø1" bore. Further details on each adapter and its compatibility with our line of optomechanics can be found below.



Click to Enlarge  
MK11F Mounting a  
CPS635R Laser Diode  
Module

Thorlabs also offers a Mini-Series kinematic mount for Ø11 mm laser modules. This kinematic mount is among our smallest kinematic mounts available and features 4-40 (M3) taps for mounting onto our Ø6 mm Mini-Series posts.

In addition, we offer mounting kits - which include a KM100T kinematic mount, post, post holder, base, and 5 VDC power supply - for an all-in-one mounting solution for these modules. Please note that the knurled knob used for focus adjustment on the CPS635F, CPS650F, and CPS670F laser modules is too large for the mounting adapter bore. This knob can be unthreaded to mount the diode module in the same manner as the collimated versions. Make sure to loosen the setscrews locking the knob in place before unthreading; not doing so can damage the threading. Alternatively, the module can be mounted by threading the cord and phono plug through the adapter first.

[Hide Pin Diagrams](#)

## PIN DIAGRAMS

### CPS Laser Power Connector

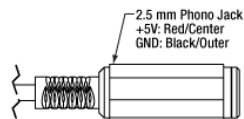

### LDS5 and CPS1 Power Supply Connector

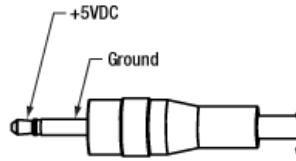

[Hide Laser Safety](#)

## LASER SAFETY

### Laser Safety and Classification

Safe practices and proper usage of safety equipment should be taken into consideration when operating lasers. The eye is susceptible to injury, even from very low levels of laser light. Thorlabs offers a range of laser safety accessories that can be used to reduce the risk of accidents or injuries. Laser emission in the visible and near infrared spectral ranges has the greatest potential for retinal injury, as the cornea and lens are transparent to those wavelengths, and the lens can focus the laser energy onto the retina.

### Safe Practices and Light Safety Accessories

- Thorlabs recommends the use of safety eyewear whenever working with laser beams with non-negligible powers (i.e., > Class 1) since metallic tools such as screwdrivers can accidentally redirect a beam.
- Laser goggles designed for specific wavelengths should be clearly available near laser setups to protect the wearer from unintentional laser reflections.
- Goggles are marked with the wavelength range over which protection is afforded and the minimum optical density within that range.
- Laser Safety Curtains and Laser Safety Fabric shield other parts of the lab from high energy lasers.
- Blackout Materials can prevent direct or

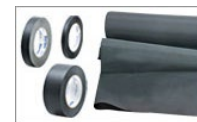

reflected light from leaving the experimental setup area.



- Thorlabs' Enclosure Systems can be used to contain optical setups to isolate or minimize laser hazards.
- A fiber-pigtailed laser should always be turned off before connecting it to or disconnecting it from another fiber, especially when the laser is at power levels above 10 mW.
- All beams should be terminated at the edge of the table, and laboratory doors should be closed whenever a laser is in use.
- Do not place laser beams at eye level.
- Carry out experiments on an optical table such that all laser beams travel horizontally.
- Remove unnecessary reflective items such as reflective jewelry (e.g., rings, watches, etc.) while working near the beam path.
- Be aware that lenses and other optical devices may reflect a portion of the incident beam from the front or rear surface.
- Operate a laser at the minimum power necessary for any operation.
- If possible, reduce the output power of a laser during alignment procedures.
- Use beam shutters and filters to reduce the beam power.
- Post appropriate warning signs or labels near laser setups or rooms.
- Use a laser sign with a lightbox if operating Class 3R or 4 lasers (i.e., lasers requiring the use of a safety interlock).
- Do not use Laser Viewing Cards in place of a proper Beam Trap.

## Laser Classification

Lasers are categorized into different classes according to their ability to cause eye and other damage. The International Electrotechnical Commission (IEC) is a global organization that prepares and publishes international standards for all electrical, electronic, and related technologies. The IEC document 60825-1 outlines the safety of laser products. A description of each class of laser is given below:

Class	Description	Warning Label
1	This class of laser is safe under all conditions of normal use, including use with optical instruments for intrabeam viewing. Lasers in this class do not emit radiation at levels that may cause injury during normal operation, and therefore the maximum permissible exposure (MPE) cannot be exceeded. Class 1 lasers can also include enclosed, high-power lasers where exposure to the radiation is not possible without opening or shutting down the laser.	
1M	Class 1M lasers are safe except when used in conjunction with optical components such as telescopes and microscopes. Lasers belonging to this class emit large-diameter or divergent beams, and the MPE cannot normally be exceeded unless focusing or imaging optics are used to narrow the beam. However, if the beam is refocused, the hazard may be increased and the class may be changed accordingly.	
2	Class 2 lasers, which are limited to 1 mW of visible continuous-wave radiation, are safe because the blink reflex will limit the exposure in the eye to 0.25 seconds. This category only applies to visible radiation (400 - 700 nm).	
2M	Because of the blink reflex, this class of laser is classified as safe as long as the beam is not viewed through optical instruments. This laser class also applies to larger-diameter or diverging laser beams.	
3R	Lasers in this class are considered safe as long as they are handled with restricted beam viewing. The MPE can be exceeded with this class of laser, however, this presents a low risk level to injury. Visible, continuous-wave lasers are limited to 5 mW of output power in this class.	
3B	Class 3B lasers are hazardous to the eye if exposed directly. However, diffuse reflections are not harmful. Safe handling of devices in this class includes wearing protective eyewear where direct viewing of the laser beam may occur. In addition, laser safety signs lightboxes should be used with lasers that require a safety interlock so that the laser cannot be used without the safety light turning on. Class-3B lasers must be equipped with a key switch and a safety interlock.	
4	This class of laser may cause damage to the skin, and also to the eye, even from the viewing of diffuse reflections. These hazards may also apply to indirect or non-specular reflections of the beam, even from apparently matte surfaces. Great care must be taken when handling these lasers. They also represent a fire risk, because they may ignite combustible material. Class 4 lasers must be equipped with a key switch and a safety interlock.	
All class 2 lasers (and higher) must display, in addition to the corresponding sign above, this triangular warning sign		

[Hide Laser Modules: 405 nm - 532 nm](#)

## Laser Modules: 405 nm - 532 nm

Click Image for Full View (Not to Scale)					
<b>Item #</b>	CPS405	CPS450	CPS520 <sup>a</sup>	CPS532 <sup>b</sup>	CPS532-C2
<b>Type</b>	Fixed	Fixed	Fixed	Fixed	Fixed
<b>Wavelength (Typical)</b>	405 nm	450 nm	520 nm	532 nm	532 nm
<b>Power (Typical)</b>	4.5 mW	4.5 mW	4.5 mW	4.5 mW	0.9 mW
<b>Laser Safety Class</b>	3R	3R	3R	3R	2

Beam Shape <sup>c</sup> (Click for Profile)	3.8 mm x 1.8 mm	3.2 mm x 1.0 mm	4.6 mm x 1.7 mm	Ø3.5 mm	Ø3.5 mm
Housing Dimensions	Ø11.0 mm x 40 mm	Ø11.0 mm x 40 mm	Ø11.0 mm x 40 mm	Ø11.0 mm x 72.8 mm	Ø11.0 mm x 72.8 mm
Specifications					

- We also offer a USB-powered laser module with a 520 nm typical center wavelength and 0.9 mW output power.
- The CPS532 should be mounted in order to facilitate heat dissipation; we recommend using our CPS11K(-EC) laser diode module mounting kit, sold below.
- The beam size was measured at a distance of 2" (50.8 mm) from the front of the housing. The beam profile was obtained using a Thorlabs CCD beam profiler with an OD 4.0 neutral density filter.

Part Number	Description	Price	Availability
CPS405	Collimated Laser Diode Module, 405 nm, 4.5 mW, Elliptical Beam, Ø11 mm Housing	\$204.52	Today
CPS450	Collimated Laser Diode Module, 450 nm, 4.5 mW, Elliptical Beam, Ø11 mm Housing	\$234.82	Today
CPS520	Collimated Laser Diode Module, 520 nm, 4.5 mW, Elliptical Beam, Ø11 mm Housing	\$204.52	Today
CPS532	Collimated Laser-Diode-Pumped DPSS Laser Module, 532 nm, 4.5 mW, Round Beam, Ø11 mm Housing	\$172.06	Today
CPS532-C2	Collimated Laser-Diode-Pumped DPSS Laser Module, 532 nm, 0.9 mW, Round Beam, Ø11 mm Housing	\$172.06	Today

[Hide Laser Modules: 635 nm](#)

### Laser Modules: 635 nm

Click Image for Full View (Not to Scale)				
Item #	CPS635R <sup>a</sup>	CPS635	CPS635S	CPS635F <sup>b</sup>
Type	Fixed	Fixed	Fixed	Adjustable
Wavelength (Typical)	635 nm	635 nm	635 nm	635 nm
Power (Typical)	1.2 mW	4.5 mW	4.5 mW	4.5 mW
Laser Safety Class	3R	3R	3R	3R
Beam Shape <sup>c</sup> (Click for Profile)	Ø2.9 mm	4.5 mm x 1.0 mm	3.8 mm x 1.2 mm	Collimated 5.0 mm x 1.9 mm
Housing Dimensions	Ø11.0 mm x 58.0 mm	Ø11.0 mm x 40.0 mm	Ø8.0 mm x 30 mm	Ø11.0 mm x 54 mm
Specifications				

- We also offer a USB-powered laser module with a 635 nm typical center wavelength.
- Focus can be adjusted by loosening the knurled knob at the front of the laser housing. As the knob is turned, the lens will translate without rotation. Please note that the rotation of the knob can be locked with two setscrews using the provided 0.9 mm hex wrench.
- The beam size was measured at a distance of 2" (50.8 mm) from the front of the housing. The beam profile was obtained using a Thorlabs CCD beam profiler with an OD 4.0 neutral density filter.

Part Number	Description	Price	Availability
CPS635R	Collimated Laser Diode Module, 635 nm, 1.2 mW, Round Beam, Ø11 mm Housing	\$97.39	Today
CPS635	Collimated Laser Diode Module, 635 nm, 4.5 mW, Elliptical Beam, Ø11 mm Housing	\$96.05	Today
CPS635S	Collimated Laser Diode Module, 635 nm, 4.5 mW, Elliptical Beam, Ø8 mm Housing	\$90.63	Today
CPS635F	Adjustable Focus Laser Diode Module, 635 nm, 4.5 mW, Elliptical Beam, Ø11 mm Housing	\$110.37	Today

[Hide Laser Modules: 650 nm - 780 nm](#)

### Laser Modules: 650 nm - 780 nm

Click Image for Full View (Not to Scale)			
Item #	CPS650F <sup>a</sup>	CPS670F <sup>a</sup>	CPS780S
Type	Adjustable	Adjustable	Fixed
Wavelength (Typical)	650 nm	670 nm	780 nm

Power (Typical)	4.5 mW	4.5 mW	2.5 mW
Laser Safety Class	3R	3R	3R
Beam Shape <sup>b</sup> (Click for Profile)	Collimated 5.0 mm x 2.4 mm	Collimated 5.0 mm x 2.4 mm	3.8 mm x 1.6 mm
Housing Dimensions	Ø11.0 mm x 54 mm	Ø11.0 mm x 54 mm	Ø8.0 mm x 30 mm
Specifications			

- Focus can be adjusted by loosening the knurled knob at the front of the laser housing. As the knob is turned, the lens will translate without rotation. Please note that the rotation of the knob can be locked with two setscrews using the provided 0.9 mm hex wrench.
- The beam size was measured at a distance of 2" (50.8 mm) from the front of the housing. The beam profile was obtained using a Thorlabs CCD beam profiler with an OD 4.0 neutral density filter.

Part Number	Description	Price	Availability
CPS650F	Focus Adjustable Laser Diode Module, 650 nm, 4.5 mW, Elliptical Beam, Ø11 mm Housing	\$110.37	Today
CPS670F	Adjustable Focus Laser Diode Module, 670 nm, 4.5 mW, Elliptical Beam, Ø11 mm Housing	\$125.53	Today
CPS780S	Collimated Laser Diode Module, 780 nm, 2.5 mW, Elliptical Beam, Ø8 mm Housing	\$108.21	Today

[Hide Laser Modules: 808 nm - 980 nm](#)

### Laser Modules: 808 nm - 980 nm

Click Image for Full View (Not to Scale)				
Item #	CPS808A	CPS808S	CPS830	CPS830S
Type	Fixed	Fixed	Fixed	Fixed
Wavelength (Typical)	808 nm	808 nm	830 nm	830 nm
Power (Typical)	2.5 mW	2.5 mW	3.0 mW	3.0 mW
Laser Safety Class	3R	3R	3R	3R
Beam Shape <sup>a</sup> (Click for Profile)	4.5 mm x 1.5 mm	3.8 mm x 1.5 mm	4.4 mm x 1.1 mm	4.0 mm x 1.3 mm
Housing Dimensions	Ø11.0 mm x 40 mm	Ø8.0 mm x 30 mm	Ø11.0 mm x 40 mm	Ø8.0 mm x 30 mm
Specifications				

Click Image for Full View (Not to Scale)				
Item #	CPS850	CPS850S	CPS980	CPS980S
Type	Fixed	Fixed	Fixed	Fixed
Wavelength (Typical)	850 nm	850 nm	980 nm	980 nm
Power (Typical)	3.5 mW	3.5 mW	4.5 mW	4.5 mW
Laser Safety Class	3R	3R	3R	3R
Beam Shape <sup>a</sup> (Click for Profile)	4.5 mm x 1.2 mm	3.8 mm x 1.5 mm	3.8 mm x 1.8 mm	3.8 mm x 1.8 mm
Housing Dimensions	Ø11.0 mm x 40 mm	Ø8.0 mm x 30 mm	Ø11.0 mm x 40 mm	Ø8.0 mm x 30 mm
Specifications				

- The beam size was measured at a distance of 2" (50.8 mm) from the front of the housing. The beam profile was obtained using a Thorlabs CCD beam profiler with an OD 4.0 neutral density filter.

Part Number	Description	Price	Availability
CPS808A	Collimated Laser Diode Module, 808 nm, 2.5 mW, Elliptical Beam, Ø11 mm Housing	\$186.12	Today
CPS808S	Collimated Laser Diode Module, 808 nm, 2.5 mW, Elliptical Beam, Ø8 mm Housing	\$186.12	Today
CPS830	Collimated Laser Diode Module, 830 nm, 3.0 mW, Elliptical Beam, Ø11 mm Housing	\$113.62	Today
CPS830S	Collimated Laser Diode Module, 830 nm, 3.0 mW, Elliptical Beam, Ø8 mm Housing	\$113.62	Today
CPS850	Collimated Laser Diode Module, 850 nm, 3.5 mW, Elliptical Beam, Ø11 mm Housing	\$113.62	Today
CPS850S	Collimated Laser Diode Module, 850 nm, 3.5 mW, Elliptical Beam, Ø8 mm Housing	\$113.62	Today
CPS980	Collimated Laser Diode Module, 980 nm, 4.5 mW, Elliptical Beam, Ø11 mm Housing	\$109.29	Today

CPS980S	Collimated Laser Diode Module, 980 nm, 4.5 mW, Elliptical Beam, Ø8 mm Housing	\$109.29	Today
---------	---	----------	-------

[Hide VCSEL Laser Module: 850 nm](#)

### VCSEL Laser Module: 850 nm

Click Image for Full View (Not to Scale)	
Item #	CPS850V
Type	Fixed
Wavelength (Typical)	850 nm
Power (Typical)	0.85 mW
Laser Safety Class	3R
Beam Shape <sup>a</sup> (Click for Profile)	Ø2.2 mm
Housing Dimensions	Ø11.0 mm x 40 mm
Specifications	

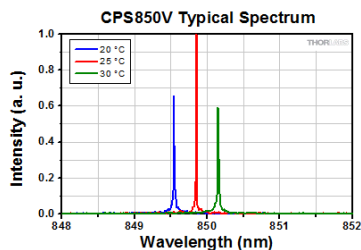

The CPS850V Collimated VCSEL Module has a single-wavelength output with a narrow linewidth. Graph above shows the typical spectrum taken at 20 °C, 25 °C, and 30 °C using a Thorlabs Optical Spectrum Analyzer. The apparent linewidth is limited by the measurement resolution, which is 7.5 GHz (0.25 cm<sup>-1</sup>). This data is typical and will vary for each module.

a. The beam size was measured at a distance of 2" (50.8 mm) from the front of the housing. The beam profile was obtained using a Thorlabs CCD beam profiler with an OD 4.0 neutral density filter.

Part Number	Description	Price	Availability
CPS850V	Customer Inspired! Collimated VCSEL Diode Module, 850 nm, 0.85 mW, Circular Beam, Ø11 mm Housing	\$233.74	Lead Time

[Hide Laser Module Mounting Adapters](#)

### Laser Module Mounting Adapters

These adapters are available for those wishing to mount the laser module housing into SM1 (1.035"-40) lens tubes, 30 mm cage systems, Ø1/2" posts, or Ø1/2" or Ø1" mounts. Please see the application photos in the *Overview* tab for more details. The AD8F and AD11F are also offered as part of a series of mounting kits; see below for details.

The KAD8F, KAD8NT, KAD11F, and KAD11NT Adapters provide ±6° of pitch and yaw adjustment. Two 80 TPI fine adjustment screws on the front plate of the adapter control the pitch and yaw position and can be turned using a 5/64" (2.0 mm) hex key.

Please note that the knurled knob used for focus adjustment on the CPS635F, CPS650F, and CPS670F laser modules is too large for the mounting adapter bore. This knob can be unthreaded to mount the module in the same manner as the collimated versions, as shown in the animation to the right. Please make sure to loosen the setscrews locking the knob in place before unthreading; not doing so can damage the threading. Alternatively, the module can be mounted by threading the cord and phono plug through the adapter first.

Click Image to Enlarge								
Item #	AD8F	KAD8F	KAD8NT	AD11BA	AD11F	AD11NT	KAD11F	KAD11NT
Description	Externally SM1-Threaded Adapter	Externally SM1-Threaded Kinematic Adapter with Pitch and Yaw Adjustment	Unthreaded Kinematic Adapter with a 1" Outer Diameter and Pitch and Yaw Adjustment	Unthreaded Adapter with a 1/2" Outer Diameter	Externally SM1-Threaded Adapter	Unthreaded Adapter with a 1" Outer Diameter	Externally SM1-Threaded Kinematic Adapter with Pitch and Yaw Adjustment	Unthreaded Kinematic Adapter with a 1" Outer Diameter and Pitch and Yaw Adjustment
Diode Module Housing Diameter	8 mm			11 mm				

Part Number	Description	Price	Availability
AD8F	SM1-Threaded Adapter for Ø8 mm Cylindrical Components	\$30.57	Today
KAD8F	SM1-Threaded Kinematic Pitch/Yaw Adapter for Ø8 mm Cylindrical Components	\$66.28	Today
KAD8NT	Ø1" Kinematic Pitch/Yaw Adapter for Ø8 mm Cylindrical Components	\$63.04	Today
AD11BA	Ø1/2" Unthreaded Adapter for Ø11 mm Cylindrical Components	\$20.99	Today
AD11F	SM1-Threaded Adapter for Ø11 mm Cylindrical Components	\$30.84	Today

AD11NT	Customer Inspired! Ø1" Unthreaded Adapter for Ø11 mm Cylindrical Components	\$24.35	5-8 Days
KAD11F	SM1-Threaded Kinematic Pitch/Yaw Adapter for Ø11 mm Cylindrical Components	\$69.79	Today
KAD11NT	Ø1" Kinematic Pitch/Yaw Adapter for Ø11 mm Cylindrical Components	\$66.28	Today

[Hide Laser Module Kinematic Mount](#)

### Laser Module Kinematic Mount



- ▶ Securely Mount Ø11 mm Laser Diode Modules
- ▶ Angular Range: ±4°
- ▶ Compact Nominal Footprint: 0.79" x 0.52" (20.0 mm x 13.3 mm)
- ▶ Resolution: 0.187 mrad (0.011°) per Revolution via Two M2.5 x 0.20 Precision Adjusters
- ▶ 4-40 (M3) Mounting Holes Allow for Left- or Right-Handed Orientation



Click to Enlarge  
MK11F Mounting a  
CPS635R Laser Diode  
Module

Thorlabs' Mini-Series Kinematic Mount for Cylindrical Components is our most compact solution for mounting the Ø11 mm laser modules sold above. This two-adjuster kinematic mount features a nominal 0.79" x 0.52" (20.0 mm x 13.2 mm) footprint, which is the same as our Mini-Series kinematic mirror mounts. Cylindrical components are secured at three points using a nylon-tipped locking screw and a double-bored mounting hole. Both the nylon-tipped setscrew and the two M2.5 x 0.20 adjuster screws accept a 0.050" (1.3 mm) hex key (not included).

For ease of adjustment, we recommend using the 0.050" hex key thumbscrews. We also offer a locking collar and spanner wrench for locking the adjuster screws in a desired position or for creating a hard stop.

Part Number	Description	Price	Availability
MK11F/M	Mini-Series Kinematic Mount for Ø11 mm Cylindrical Components, M3 Taps	\$95.48	Today
MK11F	Mini-Series Kinematic Mount for Ø11 mm Cylindrical Components, 4-40 Taps	\$95.48	Lead Time

[Hide Laser Module Mounting Kit](#)

### Laser Module Mounting Kit



- ▶ Includes All Necessary Mounting Hardware and Power Source
- ▶ Compatible with Our Range of Laser Modules
  - ▶ CPS08K(-EC): Ø8 mm Module Housing
  - ▶ CPS11K(-EC): Ø11 mm Module Housing
- ▶ LDS5(-EC) 5 VDC Power Supply Included



Click to Enlarge  
CPS5650F Mounted on a  
CPS11K Kit

Mounting Kit Components				
Item #	CPS08K	CPS08K-EC	CPS11K	CPS11K-EC
Laser Module Mounting Adapter	AD8F		AD11F	
Kinematic Mirror Mount	KM100T			
Ø1/2" Post	TR3	TR75/M	TR3	TR75/M
Ø1/2" Post Holder	PH3	PH75/M	PH3	PH75/M
Mounting Base	BA2	BA2/M	BA2	BA2/M
Power Supply	LDS5	LDS5-EC	LDS5	LDS5-EC

These Laser Module Mounting Kits contain all of the components needed to mount and power our laser modules (i.e., a power supply with a selectable line voltage of 115 V or 230 V, a location-specific power cable, and a hex key to secure the laser module to the mount). For Ø8 mm housings, choose the CPS08K(-EC) kit, and for Ø11 mm housings, choose the CPS11K(-EC) kit.

Please see the table in the upper right for a list of components included in each mounting kit. For alternate mounting options, please see our selection of mounting adapters above (adapters compatible with this kit must be externally SM1 threaded). For individual power supplies, including a 5 VDC external battery pack, see below.

Part Number	Description	Price	Availability
CPS08K-EC	Customer Inspired! Ø8 mm Laser Diode Module Mounting Kit, 230 V	\$216.42	Today
CPS11K-EC	Customer Inspired! Ø11 mm Laser Diode Module Mounting Kit, 230 V	\$217.51	Today
CPS08K	Customer Inspired! Ø8 mm Laser Diode Module Mounting Kit, 120 V	\$216.42	Today
CPS11K	Customer Inspired! Ø11 mm Laser Diode Module Mounting Kit, 120 V	\$217.51	Today

[Hide 5 VDC Regulated Power Supply](#)

### 5 VDC Regulated Power Supply



- ▶ Compatible with CPS Laser Modules
- ▶ 5 VDC Power Output
- ▶ 6 ft (183 cm) Cable with 2.5 mm Phono Plug

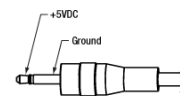

LDS5 Pin Diagram

The LDS5 is a 5 VDC power supply that is ideal for use with our CPS laser modules. A 6 ft (183 cm) cable with a 2.5 mm phono plug extends from the body of the power supply for connection to a CPS module.

The power supply has a selectable line voltage of 115 or 230 V. A 120 VAC power cable is included with the LDS5, while the LDS5-EC comes with a 230 VAC power cable. To order this item with a different power cable, please contact tech support.

Part Number	Description	Price	Availability
LDS5-EC	5 VDC Regulated Power Supply, 2.5 mm Phono Plug, 230 VAC	\$92.26	Today
LDS5	5 VDC Regulated Power Supply, 2.5 mm Phono Plug, 120 VAC	\$92.26	Today

[Hide 5 VDC External Battery Pack](#)

### 5 VDC External Battery Pack



- ▶ Portable USB Battery Pack with 5 VDC Output
- ▶ Compatible with CPS Laser Modules
- ▶ 10 000 mAh Capacity

Thorlabs offers the CPS1 Battery Pack for powering our CPS laser modules and other USB-powered devices. The CPS1 battery pack outputs 5 V and offers 10 000 mAh capacity. A fully charged CPS1 battery pack can power any CPS laser module for at least 36 hours of continuous operation. The pack includes a USB-to-Micro-USB cable for charging and a custom USB-to-Phono cable for powering the CPS laser module. To activate the battery, simply push the power button once. The pack may be charged using standard 5 V USB chargers for portable devices or using a computer USB port. While the battery pack is charging, it can still supply power to an attached laser module.

The CPS1 Battery Pack also includes an LED flashlight adjacent to the micro-USB port. The flashlight is activated and deactivated by holding the power for two seconds.

When connecting the CPS Diode Module, the module and adapter should be connected first. Then the adapter cable should be plugged into the isolated power supply to avoid a short circuit in the phono jack. Please note that the USB adapter included with this battery pack is not intended to be used with power supplies that are not current-limited or isolated from ground, such as some computers or laptops.

**Please note:** Due to shipping restrictions for lithium ion cells, the CPS1 battery pack is not available for purchase in certain countries. In countries where it is available, the battery pack must be shipped separately using specifically regulated shipping methods and may require special shipping and handling charges. Our sales team is available to answer additional questions concerning the shipment of this battery pack.

Close

Albania	Ecuador	Macedonia	Rwanda
Algeria	Egypt	Madagascar	Saint Martin
American Samoa	Equatorial Guinea	Malawi	Samoa
Angola	Eritrea	Maldives, Republic of	Saudi Arabia
Argentina	Estonia	Mali	Senegal
Armenia	Ethiopia	Malta	Serbia
Azerbaijan	Faeroe Islands	Marshall Islands	Serbia-Montenegro
Bangladesh	Fiji	Martinique	Serbia-Montenegro Old
Belarus	French Guiana	Mauritania	Seychelles
Belize	French Polynesia	Mauritius	Sierra Leone
Benin	Gabon	Micronesia	Solomon Islands
Bermuda	Gambia	Moldova	Somalia
Bhutan	Georgia, Republic of	Mongolia	South Africa, Republic of
Bolivia	Ghana	Montenegro	Sri Lanka
Bonaire, Sint Eustatius and Saba	Gibraltar	Montserrat	Sudan
Bosnia-Herzegovina	Greenland	Morocco	Suriname
Botswana	Guinea	Mozambique	Swaziland
British Virgin Islands	Guinea Bissau	Myanmar	Tanzania
Brunei	Honduras	Namibia	Togo
Bulgaria	Iceland	Nepal	Tonga
Burkina Faso	India	New Caledonia	Tunisia
Burundi	Iran	New Zealand	Turkey
Cambodia	Iraq	Nicaragua	Turkmenistan, Republic of
Cameroon	Ivory Coast	Niger	Uganda
Cape Verde	Jordan	Nigeria	Ukraine
Central African Republic	Kazakhstan	Northern Mariana Islands	Uruguay
Chad	Kenya	Oman	Uzbekistan
Chile	Kyrgystan	Pakistan	Vanuatu
Congo	Laos	Palau	Venezuela
Congo, Dem Rep of	Latvia	Palestine Autonomous	Wallis & Futuna Islands
Cook Islands	Lebanon	Papua New Guinea	Zambia
Curacao	Lesotho	Paraguay	Zimbabwe
Cyprus	Liberia	Peru	
Djibouti	Libya Reunion	Romania	
East Timor	Macau	Russia	

This battery cannot be shipped to certain postal codes in and around Perth, Australia.

Part Number	Description	Price	Availability
CPS1	Customer Inspired! 5 VDC Battery Pack for CPS Laser Diodes, 10 000 mAh	\$37.61	Lead Time



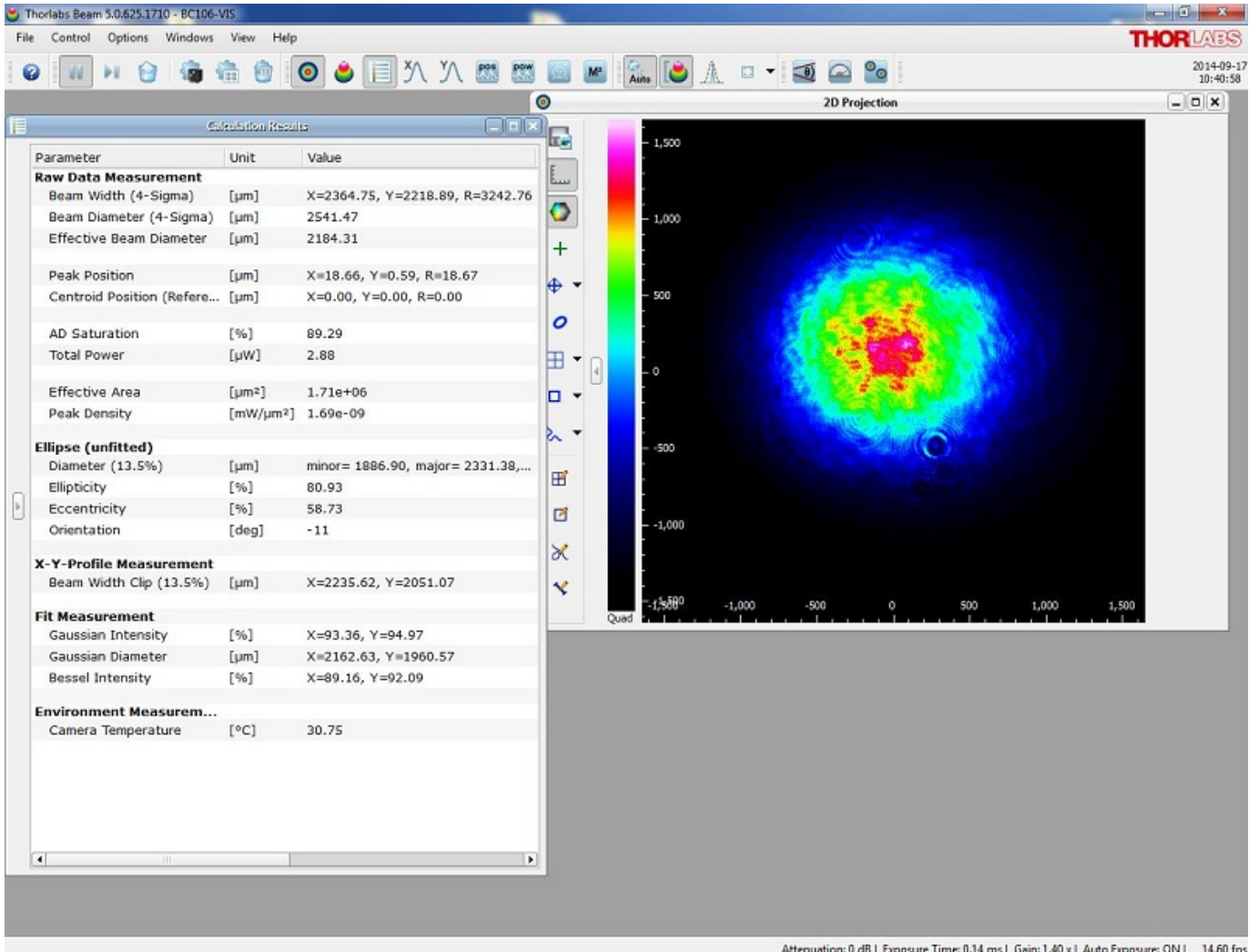
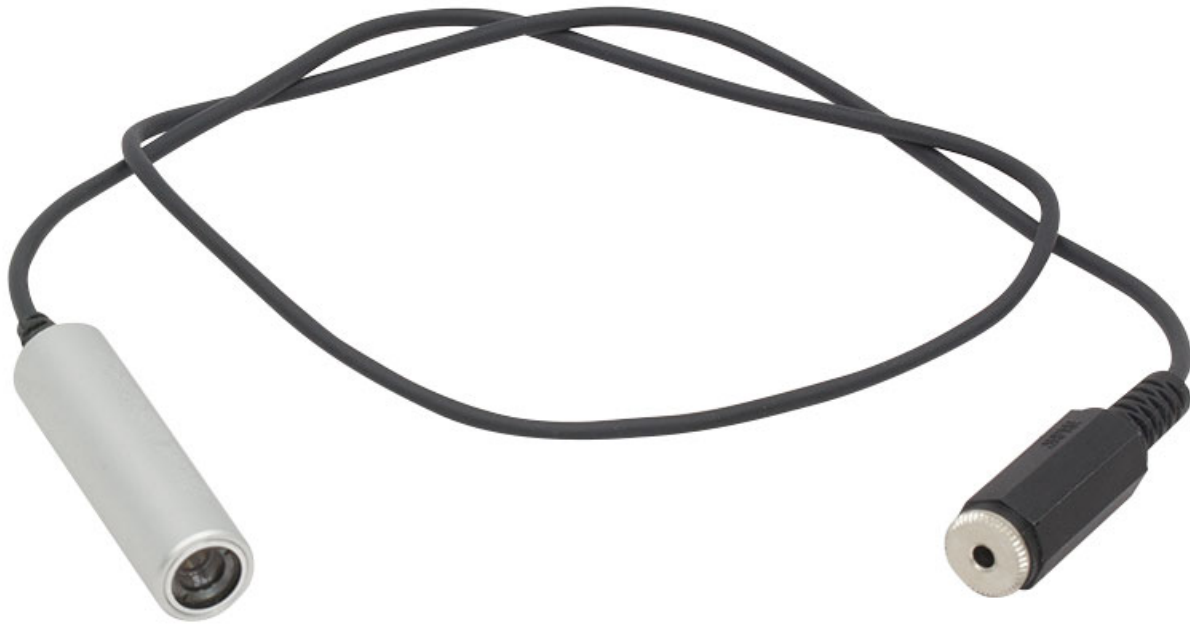

Specifications Typical Spectrum Drawing

General Specifications

Characteristic	
Housing Material	Aluminum
Housing Dimensions	Ø11.0 mm x 40 mm
Beam Size <sup>a</sup>	Circular, Ø2.2 mm
Operating Temperature	-10 to 60 °C
Storage Temperature	-30 to 70 °C
Operating Voltage	4.9 V to 5.2 V
Laser Safety Class	3R
Individual Data Sheet <sup>b</sup>	Yes
Mounting Adapter	AD11BA, AD11F, AD11NT, KAD11F, KAD11NT
Compatible Power Supply (Not Included)	LDSS, CPS1

a. The beam size was measured at a distance of 2" (50.8 mm) from the front of the housing.  
 b. This product ships with individual test data sheet that includes the center wavelength, power stability, and operating current.

Optical Electrical Characteristics

Characteristic	MIN	TYP	MAX	UNIT
Wavelength	840	850	860	nm
Optical Output Power (CW)	0.7	0.85	1.0	mW
Polarization State Extinction Ratio	-	20	-	dB
Power Stability (8 Hours)	-	-	2	%
Power Stability (1 Minute)	-	-	1	%
Axis Deviation <sup>a</sup>	-	-	5	mrad
Beam Divergence	-	-	1.5	mrad
Operating Current (CW)	-	6	10	mA

a. Max Axis Deviation is the parallelism between the module housing and the output beam.

Auto CAD PDF DXF Solidworks eDrawing Step Spec Sheet CE Certificate

Specifications Typical Spectrum Drawing

CPS850V Typical Spectrum

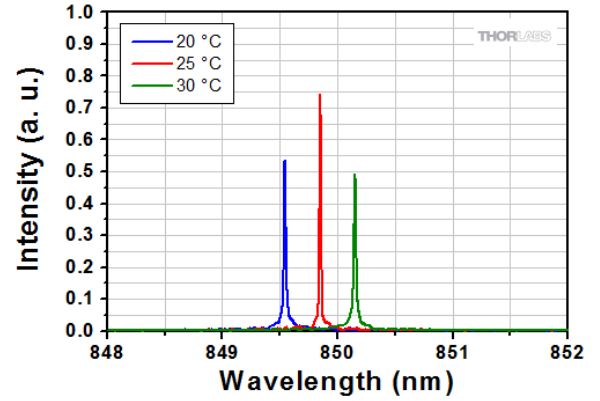

Spectrum of the CPS850V Diode Module taken at 20 °C, 25 °C, and 30 °C. The measurement was taken using Thorlabs OSA201 Spectrum Analyzer. The apparent linewidth is limited by the measurement resolution, which is 7.5 GHz (0.25 cm<sup>-1</sup>). This data is typical and will vary for each module.

Auto CAD PDF DXF Solidworks eDrawing Step Spec Sheet CE Certificate

Specifications Typical Spectrum Drawing

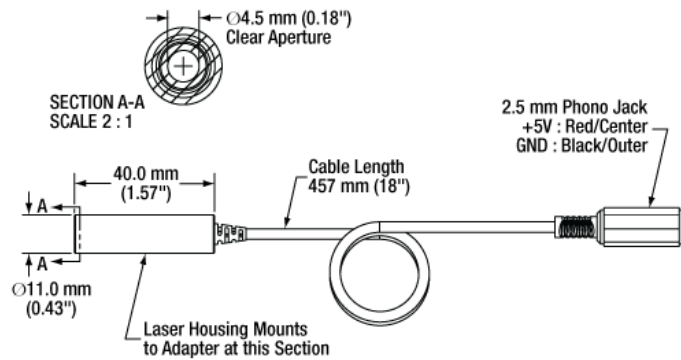

Auto CAD PDF DXF Solidworks eDrawing Step Spec Sheet CE Certificate