

## CAL110 - October 1, 2020

Item # CAL110 was discontinued on October 1, 2020. For informational purposes, this is a copy of the website content at that time and is valid only for the stated product.

### CALLISTO 930 NM OCT IMAGING SYSTEM

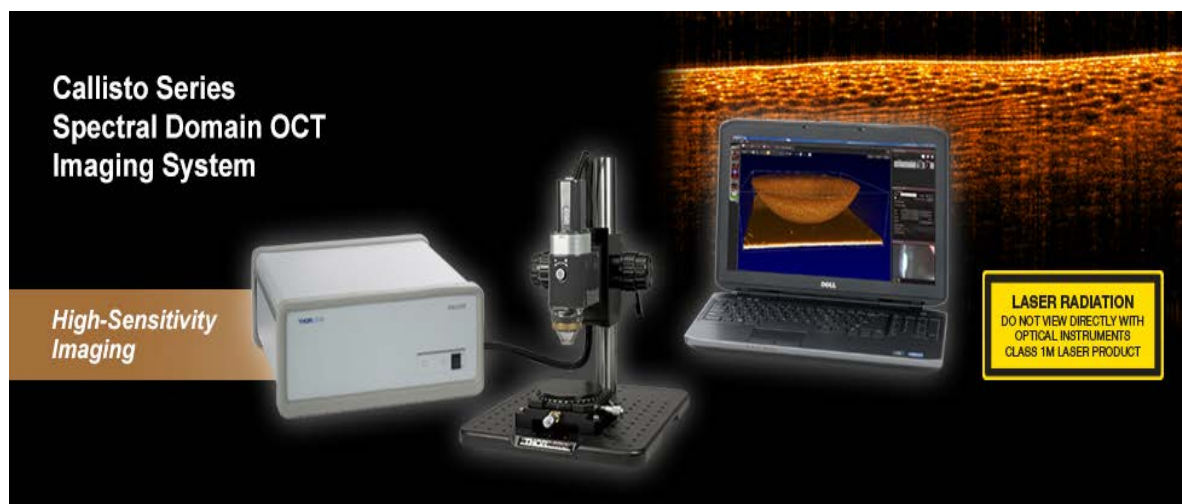

#### OVERVIEW

##### Features

- Configurable OCT Systems Optimized for High-Sensitivity Imaging
  - 1.2 kHz A-Scan Rate and 107 dB Sensitivity
  - 7  $\mu\text{m}$  Axial Resolution in Air with 1.7 mm Imaging Depth (930 nm Center Wavelength)
- Includes Computer and ThorImage<sup>®</sup>OCT Software Package (See the *Software* Tab)
- Build-Your-Own and Preconfigured Systems Available
- See the *Brochures* Tab for More Information on Thorlabs' OCT Systems

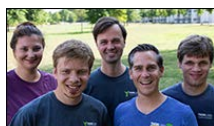

OCT Applications Team Based in Lübeck, Germany

We're Happy to Assist!

Contact Us

##### Exploring the Options?

We can provide recommendations based on your needs and partner with you to obtain images of samples provided by you demonstrating the effects of various components on image quality. Demos of our OCT systems can be arranged at our Sterling, VA (USA); Shanghai, China; Tokyo, Japan; and Lübeck, Germany facilities.

##### In the Budgetary Phase?

System prices vary based on the exact components. Through our conversations, we can ensure your system quote is tailored to your requirements.

##### OEM or Custom Projects?

Click here to learn about our OEM capabilities.

##### Choose Components to Build or Customize Your OCT System

- One 930 nm, High-Sensitivity Base Unit (Required)
- Standard, User-Customizable, and Handheld Scanners Available
- Scan Lens Kits to Optimize Lateral Resolution and Focal Length for Your Application
- Ring- and Immersion-Style Sample Z-Spacers for Air or Liquid Imaging Applications
- Scanner Stand and Translation Stage Accessories
- Contact Our OCT Team to Request a Quote and Discuss Building a System

Optical Coherence Tomography (OCT) is a noninvasive optical imaging technique that produces real-time, 2D cross-sectional and 3D volumetric images of a sample. This technique provides structural information about the sample based on light backscattered from different layers of material within that sample, producing images with micron-level resolution and millimeters of imaging depth. OCT imaging can be considered as an optical analog to ultrasound imaging that achieves higher resolution at the cost of decreased penetration depth. In addition to high resolution, the non-contact, noninvasive nature of OCT makes it well suited for imaging samples such as biological tissue, small animals, and industrial materials.

Thorlabs' Callisto Series of OCT Imaging Systems are designed for high sensitivity and are ideal for imaging static, *in vitro* samples. The 64-bit software pre-installed on the included computer displays and processes 2D and 3D OCT data in real time. Choose from a number of scanner options including a robust standard scanner, user-customizable scanner, and the portable handheld scanner. Optional accessories are available below to customize your OCT system to meet the requirements of your application. Additionally, Thorlabs offers a complete, preconfigured OCT system for 930 nm based on the components sold on this page.

The components below can also be used to upgrade your existing Thorlabs OCT system with additional features and are fully compatible out of the box with



Application Articles

Thorlabs' OCT systems and accessories. While most systems are upgradable, we recommend contacting the OCT Team to determine the optimal solution for your system and intended application.

Click on the Image Below or in the Table to the Right for Details on Customization Options



Components and Accessories
OCT Base Unit (Computer Included)
Scanning System
Scan Lens Kit
Reference Length Adapter (For Standard Scanners Only)
Sample Z-Spacer
Adjustable Scanner Stand
Translation Stage
Preconfigured System (Z-Spacer Not Included)

## SOFTWARE

### ThorImage®OCT Software Index

- Introduction
- Imaging Modes
  - 1D Mode for Single Point Measurements
  - 2D Mode for Cross-Sectional Imaging
  - 3D Mode for Volume Imaging
  - Doppler Mode for Doppler Flow Imaging
  - Speckle Variance Mode for Angiographic Imaging
- Externally-Triggered Acquisition for Synchronized Measurements
- Easy Probe Calibration for Different Configurations
- Video Showing Screencast of Rendering Capabilities

### ThorImageOCT Software

- Interactive Scan Position Control through Video Display for Common Line Scans or Freeform Pattern Scans
- Advanced Dataset Management
- Access to Raw Spectra, Processed Data, and All Calibration Files Necessary for User-Designed Processing Routines
- High-Speed Volume Rendering of 3D Data
- Doppler and Speckle Variance Imaging
- Versatile Scan and Acquisition Control, such as Averaging or Adjustable Scan Speeds

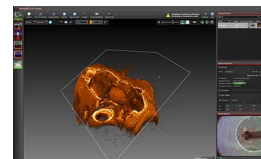

Click to Enlarge  
Rendered Volume with Modifiable Clipping Plane of a Zebrafish

ThorImageOCT is a high-performance data acquisition software, which is included with all Thorlabs OCT systems. This 64-bit Windows-based software package performs data acquisition, processing, scan control, and displays OCT images. Additionally, NI LabVIEW and C-based Software Development Kits (SDKs) are available, which contain a complete set of libraries for measurement control, data acquisition and processing, as well as storage and display of OCT images. The SDKs provide the means for developing highly specialized OCT imaging software for every individual application.

### Scan Control

ThorImageOCT provides numerous scan and acquisition controls. The camera integrated in the scanner of our OCT systems provides live video images in the application software. Defining the scan line for 2D imaging or the scan area for 3D imaging is accomplished through the easy-to-use "Draw and Scan" feature by clicking on the video image.

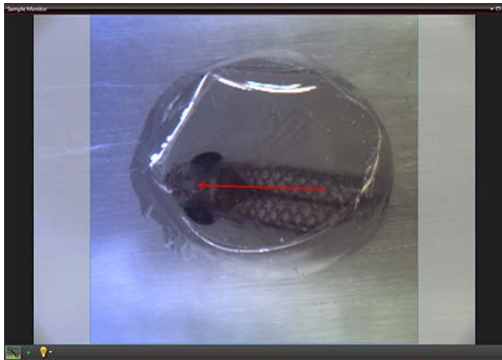

Click to Enlarge  
The Sample Monitor can be used to define the scan pattern using the "Draw and Scan" feature.

Arbitrary forms defined by the Draw & Scan feature or loaded .txt files can be scanned. The scan pattern can also be adjusted by specifying suitable parameters in the controls of the software, as shown to the right.

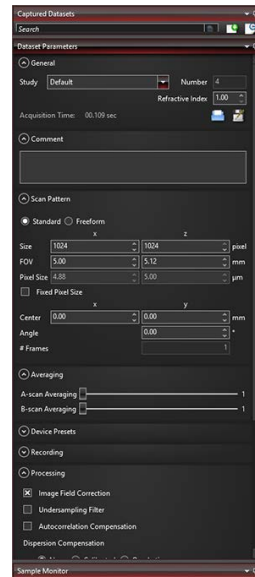

Click to Enlarge  
Various acquisition parameters can be adjusted in ThorImageOCT.

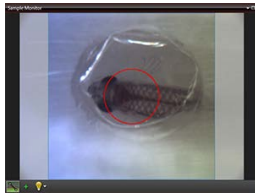

Click to Enlarge  
A predefined circle scan pattern can be loaded and scanned in the software. The size can be changed with the Zoom feature.

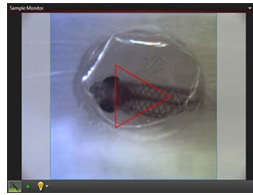

Click to Enlarge  
A predefined triangle scan pattern can be loaded and scanned in the software. The size can be changed with the Zoom feature.

Additionally, one can further set processing parameters, averaging parameters, and the speed and sensitivity of the device using device presets. By using a high-speed preset, video-like frame rates in 2D and fast volume rendering in 3D are possible, whereas high-sensitivity acquisition is enabled by choosing a preset with a lower acquisition speed.

### Dataset Management

ThorImageOCT provides advanced dataset management capabilities, which allow opening several datasets simultaneously. Datasets are uniquely defined using an identifier consisting of a study (or test series) name and an experiment number. Grouping of datasets can be achieved by using the same study name. The "Captured Datasets" list shows an overview of all open datasets, including the dataset identifier, the acquisition mode, and preview pictures of the still video image and the OCT data.

Datasets can be exported in various image formats, such as PNG, BMP, JPEG, PDF, or TIFF. The set can also be exported in complete data formats suited for post-processing purposes, such as RAW/SRM, FITS, VTK, VFF, and 32-bit floating-point TIFF.

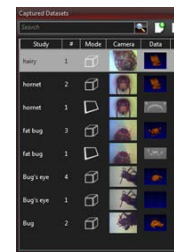

Click to Enlarge  
The Dataset Management Window of ThorImageOCT

The OCT file format native to ThorImageOCT allows OCT data, sample monitor data, and all relevant metadata to be stored in a single file. ThorImageOCT can also be installed and run on computers without OCT devices in order to view and export OCT data. The user has full access to the raw and processed data from the device, including additional data used for processing, e.g. offset errors.

### Third Party Applications

If both ImageJ and ThorImageOCT are installed on the computer, opening acquired OCT data in ImageJ is one mouse click away. This enables a flawless workflow when requiring the advanced image processing functionality provided by ImageJ. Clicking the Explorer button will open the folder in Windows Explorer where the currently active dataset is stored.

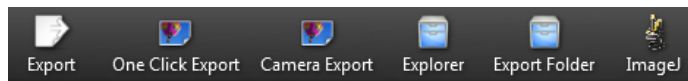

Export buttons are accessible in the Action Toolbar of ThorImageOCT.

### Imaging Modes

Different OCT imaging modes can be selected using the mode selector. If the ThorImageOCT software finds a compatible system connected and switched on, all operational modes will be selectable. If no OCT device is present, only the data viewing mode for viewing and exporting OCT data will be available.

#### 1D Mode

The 1D Mode provides the possibility to measure at a single point. The single point

measurement not only provides spectral information and depth information, but also gives the possibility to observe time related behavior of a sample with an M-Scan.

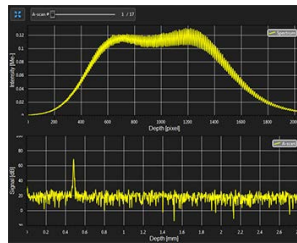

Click to Enlarge  
Spectral and Depth Information for a Single Point (A-Scan)

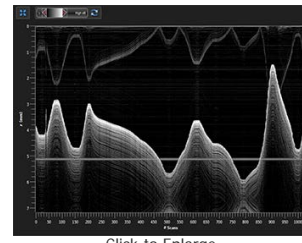

Click to Enlarge  
Several A-Scans at a Single Point Over Time (M-Scan)

## 2D Mode

In the 2D imaging mode, the probe beam scans in one direction, acquiring cross-sectional OCT images which are then displayed in real time. Line averaging before or after the Fast Fourier Transform (FFT) is available, as well as B-Scan averaging. Image display parameters, such as color mapping, can be controlled in this mode. We have also implemented an option for automatic calculation of the optimum contrast and brightness of the displayed OCT images.

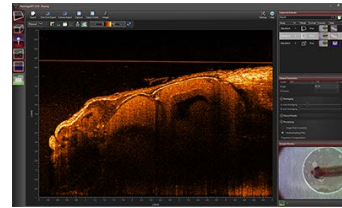

Click to Enlarge  
ThorImageOCT Window in the 2D Mode

## 3D Mode

In the 3D imaging mode, the OCT probe beam scans sequentially across the sample to collect a series of 2D cross-sectional images which are then processed to build a 3D image.

In the ThorImageOCT software, 3D volume datasets can be viewed as orthogonal cross-sectional planes (see below) and volume renderings.

The Sectional View features cross-sectional images in all three orthogonal planes, independent of the orientation in which the data was acquired. The view can be rotated as well as zoomed in and out.

The Rendering View provides a volumetric rendering of the acquired volume dataset. This view enables quick 3D visualization of the sample being imaged. Planes of any orientation can be clipped to expose structures within the volume. The 3D image can be zoomed in and out as well as rotated. Furthermore, the coloring and dynamic range settings can be adjusted.

Utilizing the full potential of our high-performance software in combination with our high-speed OCT systems, we have included a Fast Volume Rendering Mode in the ThorImageOCT software, which serves as a preview for high-resolution 3D acquisitions. In this mode, high-speed volume renderings can be displayed in real-time, providing rapid visualization of samples in three dimensions.

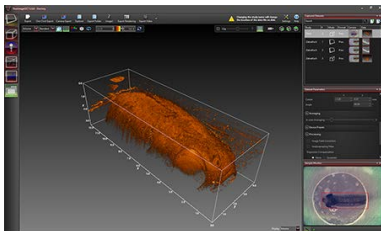

Click to Enlarge  
Rendering View of ThorImageOCT

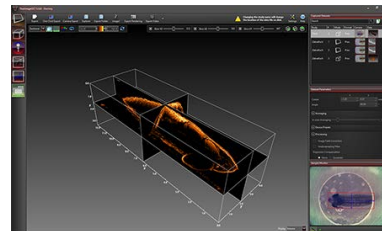

Click to Enlarge  
Sectional View of ThorImageOCT

## Doppler Mode

Doppler OCT imaging comes standard with all OCT systems. In the Doppler mode, phase shifts between adjacent A-scans are averaged to calculate the Doppler frequency shift induced by particle motion or flow. The number of lateral and axial pixels can be modified to change velocity sensitivity and resolution during phase shift calculation. The Doppler images are displayed in the main window with a color map indicating forward- or backward-directed flow, relative to the OCT beam.

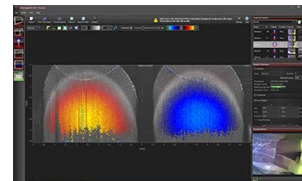

Click to Enlarge  
Doppler dataset showing the velocity of a rotated plastic stick with opposite flow directions.

## Speckle Variance Mode

The speckle variance imaging mode is an acquisition mode which uses the variance of speckle noise to calculate angiographic images. It can be used to visualize three dimensional vessel trees without requiring significant blood flow and without requiring a specific acquisition speed window. The speckle variance data can be overlaid on top of intensity pictures providing morphological information. Different color maps can be used to display the multimodal pictures.

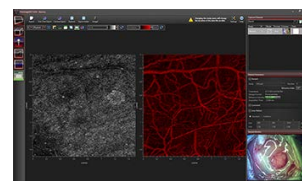

Click to Enlarge

### Externally-Triggered Acquisition

ThorImageOCT and the SDK APIs provide the ability to externally trigger the acquisition of A-Scans. This enables the user to synchronize measurements from different modalities (e.g. vibrometry and synchronized positioning) with an OCT measurement. Synchronization is greatly simplified with all current CameraLink-based Thorlabs OCT systems (a TTL level trigger signal source required). External triggering is available for all imaging modes and can be toggled in the settings dialog in ThorImageOCT.

### Easy Probe Calibration

Changing to a different scan lens kit will generally require a different probe configuration in order to adapt to changes in the optical parameters of the system. When an additional scan lens is purchased for your Thorlabs OCT scanner system, ThorImageOCT enables you to easily create a fitting configuration for your new scan lens by using the calibration sample shipped with the lens and an intuitive step-by-step calibration process (shown to the right).

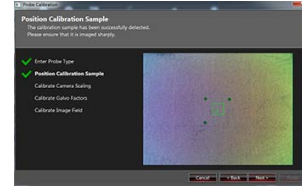

Click to Enlarge  
Probe Calibration Window in ThorImageOCT

### Video Showing Screencast of ThorImageOCT Rendering Capabilities

In this video, OCT images of a finger are acquired and manipulated in the 3D volume and cross section modes.

## OCT TUTORIAL

### Optical Coherence Tomography Tutorial

Optical Coherence Tomography (OCT) is a noninvasive optical imaging modality that provides real-time, 1D depth, 2D cross-sectional, and 3D volumetric images with micron-level resolution and millimeters of imaging depth. OCT images consist of structural information from a sample based on light backscattered from different layers of material within the sample. It can provide real-time imaging and is capable of being enhanced using birefringence contrast or functional blood flow imaging with optional extensions to the technology.

Thorlabs has designed a broad range of OCT imaging systems that cover several wavelengths, imaging resolutions, and speeds, while having a compact footprint for easy portability. Also, to increase our ability to provide OCT imaging systems that meet each customer's unique requirements, we have designed a highly modular technology that can be optimized for varying applications.

#### Application Examples



OCT is the optical analog of ultrasound, with the tradeoff being lower imaging depth for significantly higher resolution (see Figure

1). With up to 15 mm imaging range and better than 5 micrometers in axial resolution, OCT fills a niche between ultrasound and confocal microscopy.

In addition to high resolution and greater imaging depth, the non-contact, noninvasive advantage of OCT makes it well suited for imaging samples such as biological tissue, small animals, and materials. Recent advances in OCT have led to a new class of technologies called Fourier Domain OCT, which has enabled high-speed imaging at rates greater than 700,000 lines per second.<sup>1</sup>

Fourier Domain Optical Coherence Tomography (FD-OCT) is based on low-coherence interferometry, which utilizes the coherent properties of a light source to measure optical path length delays in a sample. In OCT, to obtain cross-sectional images with micron-level resolution, and interferometer is set up to measure optical path length differences between light reflected from the sample and reference arms.

There are two types of FD-OCT systems, each characterized by its light source and detection schemes: Spectral Domain OCT (SD-OCT) and Swept Source OCT (SS-OCT). In both types of systems, light is divided into sample and reference arms of an interferometer setup, as illustrated in Fig 2. SS-OCT uses coherent and narrowband light, whereas SD-OCT

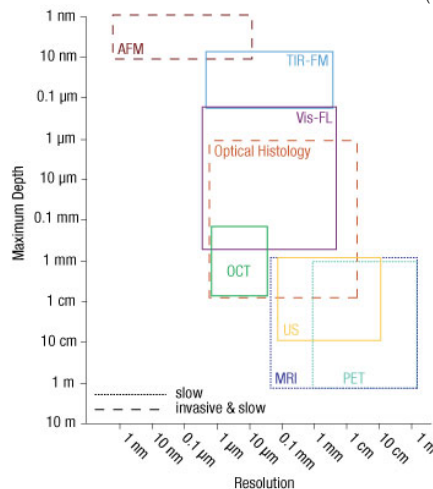

Click to Enlarge

Figure 1



systems utilize broadband, low-coherence light sources. Back scattered light, attributed to variations in the index of refraction within a sample, is recoupled into the sample arm fiber and then combined with the light that has traveled a fixed optical path length along the reference arm. A resulting interferogram is measured through the detection arm of the interferometer.

The frequency of the interferogram measured by the sensor is related to depth locations of the reflectors in the sample. As a result, a depth reflectivity profile (A-scan) is produced by taking a Fourier transform of the detected interferogram. 2D cross-sectional images (B-scans) are produced by scanning the OCT sample beam across the sample. As the sample arm beam is scanned across the sample, a series of A-scans are collected to create the 2D image.

Similarly, when the OCT beam is scanned in a second direction, a series of 2D images are collected to produce a 3D volume data set. With FD-OCT, 2D images are collected on a time scale of milliseconds, and 3D images can be collected at rates now below 1 second.

### Spectral Domain OCT vs. Swept Source OCT

Spectral Domain and Swept Source OCT systems are based on the same fundamental principle but incorporate different technical approaches for producing the OCT interferogram. SD-OCT systems have no moving parts and therefore have high mechanical stability and low phase noise. Availability of a broad range of line cameras has also enabled development of SD-OCT systems with varying imaging speeds and sensitivities.

SS-OCT systems utilize a frequency swept light source and photodetector to rapidly generate the same type of interferogram. Due to the rapid sweeping of the swept laser source, high peak powers at each discrete wavelength can be used to illuminate the sample to provide greater sensitivity with little risk of optical damage.

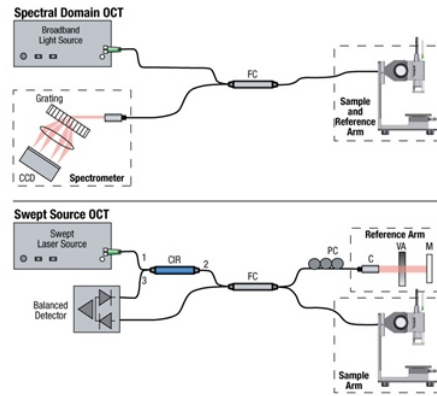

Click to Enlarge  
Figure 2

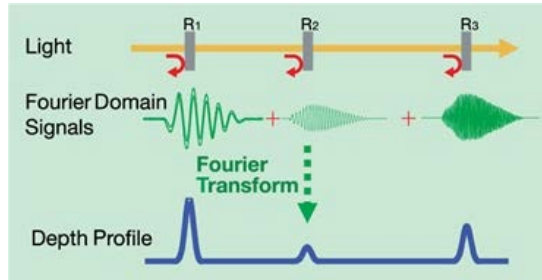

Click to Enlarge

### FD-OCT Signal Processing

In Fourier Domain OCT, the interferogram is detected as a function of optical frequency. With a fixed optical delay in the reference arm, light reflected from different sample depths produces interference patterns with the different frequency components. A Fourier transform is used to resolve different depth reflections, thereby generating a depth profile of the sample (A-scan).

<sup>1</sup>V. Jayaraman, J. Jiang, H. Li, P. Heim, G. Cole, B. Potsaid, J. Fujimoto, and A. Cable, "OCT Imaging up to 760 kHz Axial Scan Rate Using Single-Mode 1310 nm MEMS-Tunable VCSELs with 100 nm Tuning Range," CLEO 2011 - Laser Applications to Photonic Applications, paper PDPB2 (2011).

## BROCHURES

### Brochure and Configuration Chart

The buttons below link to PDFs of printable materials and a graphical customization guide for our Callisto Series OCT Systems.



# Callisto Series OCT Systems

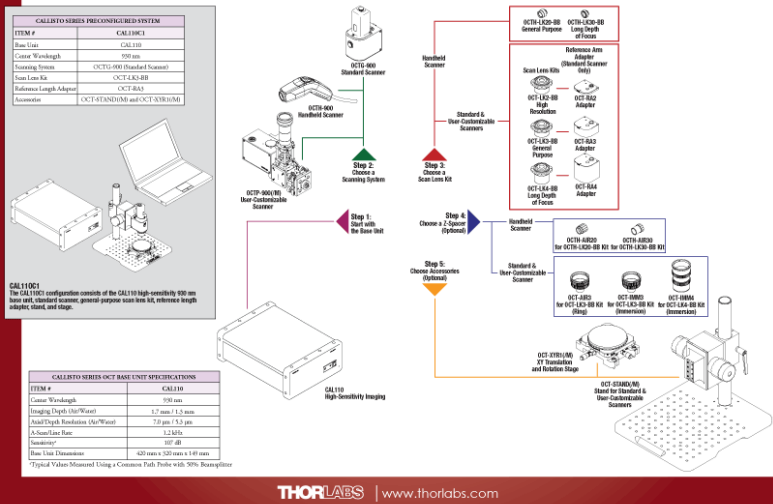

## SELECTION GUIDE

Thorlabs offers a variety of OCT Imaging Systems to meet a range of application requirements. The OCT base unit and scan lens kit are key to OCT system performance. Significant performance characteristics, including axial resolution, A-Scan rate, and imaging depth, are entirely or strongly dependent on the design of the OCT base unit. The choice of scan lens kit determines other parameters, such as lateral resolution and field of view. Thorlabs offers a variety of OCT base units and scan lens kits that provide foundations for systems with a wide range of capabilities. The tables below present key performance parameters of our base units and include links to our other OCT imaging system pages. We encourage you to contact us directly at [oct@thorlabs.com](mailto:oct@thorlabs.com) or via our online request form to discuss specific imaging requirements.

### 900 nm OCT Base Units

Base Unit Item # <sup>a</sup>	CAL110	GAN210	GAN610	GAN220	GAN620
Series Name (Click for Link)	Callisto	Ganymede			
Key Performance Feature(s)	Laptop PC for Maximum Portability	High Resolution		Very High Resolution	
		General Purpose	High Speed	General Purpose	High Speed
Center Wavelength	930 nm	930 nm		900 nm	
Imaging Depth <sup>b</sup> (Air/Water)	1.7 mm / 1.3 mm	2.9 mm / 2.2 mm	2.7 mm / 2.0 mm	1.9 mm / 1.4 mm	
Axial Resolution <sup>b</sup> (Air/Water)	7.0 μm / 5.3 μm	6.0 μm / 4.5 μm		3.0 μm / 2.2 μm	
A-Scan Line Rate	1.2 kHz	5.5 kHz to 36 kHz	5 kHz to 248 kHz	5.5 kHz to 36 kHz	5 kHz to 248 kHz
Sensitivity (Max) <sup>c</sup>	107 dB	101 dB	102 dB	101 dB	102 dB
OCT Type	Spectral Domain				

- a. These Item #s are OCT base units that can be customized using a wide selection of OCT scanners, lens kits, and optional accessories.
- b. Axial resolution and actual imaging depth are dependent on the optical properties of the sample being imaged.
- c. Values for the Callisto and Ganymede systems are typical and were measured using a scanner with a common reference/sample path and 50% path split.

### 1300 nm OCT Base Units

Base Unit Item # <sup>a</sup>	TEL210	TEL310	TEL220	TEL320	TEL210PS	TEL220PS	VEG210	VEG220
Series Name (Click for Link)	Telesto				Telesto PS-OCT		Vega	
Key Performance Feature(s)	High Imaging Depth		High Resolution		High Imaging Depth	High Resolution	Long Imaging Range	
	General Purpose	High Speed	General Purpose	High Speed	Polarization-Sensitive Imaging		General Purpose	High Speed
Center Wavelength	1325 nm		1300 nm		1325 nm	1300 nm	1300 nm	
Imaging Depth <sup>b</sup> (Air/Water)	7.0 mm / 5.3 mm		3.5 mm / 2.6 mm		7.0 mm / 5.3 mm	3.5 mm / 2.6 mm	11 mm / 8.3 mm	8.0 mm / 6.0 mm
Axial Resolution <sup>b</sup> (Air/Water)	12 μm / 9.0 μm		5.5 μm / 4.2 μm		12 μm / 9.0 μm	5.5 μm / 4.2 μm	16 μm / 12 μm	
A-Scan Line Rate	5.5 kHz to 76 kHz	10 kHz to 146 kHz	5.5 kHz to 76 kHz	10 kHz to 146 kHz	5.5 kHz to 76 kHz	5.5 kHz to 76 kHz	100 kHz	200 kHz
Sensitivity (Max) <sup>c</sup>	111 dB	109 dB	111 dB	109 dB	109 dB	109 dB	102 dB	98 dB
OCT Type	Spectral Domain						Swept Source	

- a. These Item #s are OCT base units that can be customized using a wide selection of OCT scanners, lens kits, and optional accessories.
- b. Axial resolution and actual imaging depth are dependent on the optical properties of the sample being imaged.
- c. Values for the Telesto systems are typical and were measured using a scanner with a common reference/sample path and 50% path split. Values measured for the Vega systems are typical and were measured using a scanner with a dual path setup.

### Callisto Series Complete Preconfigured System

- ▶ Complete Preconfigured 930 nm OCT Imaging System
- ▶ High-Sensitivity Imaging (See Tables Below)
- ▶ Fully Customizable Using Other Callisto Series Components

Thorlabs offers this complete, preconfigured Callisto OCT system, which is fully compatible with all Callisto Series OCT components. The CAL110C1 configuration features a center wavelength of 930 nm and is designed for high-sensitivity imaging applications.

This Callisto Series OCT system configuration is built completely from components sold in sections located lower on this page. This preconfigured system includes the three mandatory OCT system core components (the base unit, a scanning system with its reference length adapter, and a scan lens kit), as well as two optional accessories (scanner stand and translation stage). For more information about a component included in the preconfigured system, click on the component description in the table to the lower left to navigate down to the related section on this page.

For information about the CAL110C1 system or to inquire about custom configurations, please contact [oct@thorlabs.com](mailto:oct@thorlabs.com).

Preconfigured System Included Components	
System Item #	CAL110C1
Base Unit	CAL110
Scanning System	OCTG-900 (Standard Scanner)
Scan Lens Kit	OCT-LK3-BB
Reference Length Adapter	OCT-RA3
Accessories: Stand and Stage	OCT-STAND(/M) (Scanner Stand) and OCT-XYR1(/M) (Translation Stage)

- a. Click on the component description to navigate down to the related section on this page.

Preconfigured System Key Specifications	
System Item #	CAL110C1
Imaging Depth (Air/Water)	1.7 mm / 1.3 mm
Axial Resolution (Air/Water)	7.0 $\mu$ m / 5.3 $\mu$ m
Lateral Resolution	8 $\mu$ m
A-Scan/Line Rate	1.2 kHz
Sensitivity	107 dB

Part Number	Description	Price	Availability
CAL110C1	Spectral Domain OCT System, 930 nm, 7.0 $\mu$ m Resolution, 1.2 kHz	\$37,131.50	Lead Time

### OCT Base Unit (Required OCT System Component)

- ▶ 930 nm High-Sensitivity Base Unit
- ▶ 107 dB Sensitivity at 1.2 kHz A-Scan Rate
- ▶ 1.7 mm Imaging Depth and 7  $\mu$ m Axial Resolution

The imaging performance of any OCT system is largely dependent on the design and components incorporated into the base unit. All of Thorlabs' OCT Base Units include an OCT engine, high-performance computer, pre-installed software, and a software development kit (SDK). For the Callisto OCT Base Unit, the engine is comprised of a superluminescent diode light source, scanning electronics, and a linear CCD array-based spectrometer for detection. The engine and detection components are integrated into a 420 mm x 320 mm x 149 mm (16.5" x 12.6" x 5.86") unit. For a fully operational system, one scanning option and a scan lens kit must be purchased along with a base unit (sold separately below).

Thorlabs' CAL110 Base Unit is optimized for high sensitivity (107 dB) at an A-Scan line rate of 1.2 kHz. Thus, the Callisto is ideal for imaging static, *in vitro* samples that require good contrast to distinguish features. The CAL110 offers up to 1.7 mm imaging depth with 7  $\mu$ m of axial resolution.

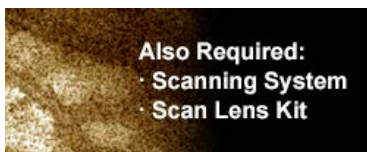

**Also Required:**  
 • Scanning System  
 • Scan Lens Kit

To be functional, an OCT system build must include a base unit, a scanning system, and a scan lens kit.

Base Unit Item #	CAL110
Center Wavelength	930 nm
Imaging Depth (Air/Water)	1.7 mm / 1.3 mm
Axial Resolution (Air/Water)	7.0 $\mu$ m / 5.3 $\mu$ m
A-Scan Line Rate	1.2 kHz
Sensitivity <sup>a</sup>	107 dB (at 1.2 kHz)
Maximum Pixels per A-Scan	512
Compatible Scanners	OCTP-900(/M), OCTG-900, and OCTH-900

- a. Typical Values Measured Using a Scanner with a Common Reference/Sample Path and 50% Path Split

Computer Specifications <sup>a</sup>	
Operating System	Windows 7 <sup>b</sup> , 64 Bit
Processor	Dual Core, $\geq$ 2.5 GHz
Memory	4 GB
Hard Drive	$\geq$ 250 GB
Data Acquisition	USB

- a. Computer Specifications Subject to Change



- a. We are in the process of switching the pre-installed operating system; some computers may come with Windows 10 installed upon delivery. This will not affect the performance of the OCT software.

Part Number	Description	Price	Availability
CAL110	Callisto OCT Base Unit, 930 nm, 7.0 $\mu\text{m}$ Resolution, 1.2 kHz	\$20,157.10	Lead Time

### Scanning Systems (Required OCT System Component)

- ▶ Scan an OCT Light Source Beam Across a Sample to Acquire 2D or 3D Images
- ▶ Three Available Options
  - ▶ Standard Scanner for High Stability and Ease-of-Use
  - ▶ User-Customizable Scanners with Open Construction for Customization of Scan Path
  - ▶ Portable Handheld Scanner for Applications Requiring High Mobility



Click to Enlarge  
Standard OCT Scanner



Click to Enlarge  
User-Customizable  
OCT Scanner



Click to Enlarge  
Handheld OCT Scanner

Thorlabs' OCT Scanning Systems are designed to scan the OCT light source beam across a sample for 2D

cross-sectional and 3D volumetric imaging. OCT applications can vary widely, from live animal imaging to industrial materials analysis, with each requiring a different set of scanning parameters. We currently offer three types of beam scanning systems for use with our Callisto Base Unit: standard, user-customizable, and handheld.

Scanner Type	Item #	Compatible Base Unit
Standard Scanner <sup>a</sup>	OCTG-900	CAL110
User-Customizable Scanner	OCTP-900(M)	
Handheld Scanner <sup>b</sup>	OCTH-900	

Each scanner contains an OCT interferometer with a sample arm and a reference arm. The reference arm of the OCT interferometer is placed near the sample and housed within the scanning system itself to guarantee the phase stability of the sample arm relative to the reference arm. To account for different sample distances and reflectivities (e.g., while imaging through water), the reference arm path length, as well as the reference arm intensity, is adjustable. To minimize image distortion caused by dispersion, our OCT systems are designed to optically match the reference and sample arm lengths to the greatest extent possible. Dispersion effects from the sample (e.g., imaging through water or glass) can be compensated for using the included ThorImage OCT software. For customers interested in dual-path setups, any of these scanners can be configured without a beamsplitter; please contact [oct@thorlabs.com](mailto:oct@thorlabs.com) for more information.

- Standard Scanner Requires Purchase of Reference Length Adapter
- Sample Z-Spacers Recommended When Using OCTH-900

All scanners are equipped with an integrated camera that can obtain real-time *en face* video of the sample during OCT measurements when used with our ThorImage OCT software (see the *Software* tab for details). Illumination of the sample is provided by a ring of user-adjustable white light LEDs around the exit aperture of each scanner.

#### Standard Scanner

The OCTG-900 Standard Scanner is ideal for imaging applications that require a stable, easy-to-operate setup. The entire design of the standard scanner is contained within a rugged, light-tight housing that minimizes the risk of misalignment. The standard scanner is equipped with a reference path length distance indicator for ease-of-use during reference adjustments. A knob located at the top of the standard scanner allows for fine adjustments to the reference path length.

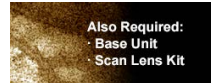

To be functional, an OCT system build must include a base unit, a scanning system, and a scan lens kit.



Click to Enlarge  
OCTH-900 Handheld  
Scanner with OCT-  
AIR30 Sample Z-  
Spacer

#### User-Customizable Scanner

The OCTP-900(M) User-Customizable Scanner is designed with an open construction to enable easy customization of the optical beam path using Thorlabs' standard optomechanical components. This scanner features SM1 (1.035"-40) ports and 4-40 tapped holes at several locations that allow mounting of SM1-threaded or 30 mm cage-compatible components, respectively. The scan lens port is directly compatible with either M25 x 0.75 or SM1-threaded components, and can be converted to other thread standards, such as RMS (0.800"-36) via our selection of thread adapters. Additional scanning and non-scanning optical input/output ports are available for integration of a laser for fluorescence excitation or additional sample illumination.

#### Compact Handheld Scanner

The compact and lightweight OCTH-900 Handheld Scanner is specifically designed for applications requiring high mobility. Easy access buttons located directly on the scanner enable fingertip control of our ThorImage OCT Software. Users can program each button from a selection of imaging and acquisition software controls and the software uses visual and audio feedback for button presses. The OCTH-900 features a removable cover under the handle that provides access to the reference length and intensity settings. Compatible scan lens kits and sample z-spacers for the OCTH-900 are sold below; z-spacers help maintain the correct working distance when using the handheld scanner. Please note that due to the limitations of the internal MEMS scanner, the frame rate (i.e., B-Scan rate) is limited to 25 frames per second when using the handheld scanner.

Part Number	Description	Price	Availability
OCTP-900/M	Customer Inspired!&nbsp;User-Customizable Scanner for 900 nm & 930 nm SD-OCT Systems, Metric	\$12,730.80	Lead Time
OCTG-900	Standard Scanner for 900 nm & 930 nm SD-OCT Systems	\$12,200.35	Lead Time
OCTH-900	Handheld Scanner for 900 nm & 930 nm SD-OCT Systems	\$10,502.91	Lead Time
OCTP-900	Customer Inspired!&nbsp;User-Customizable Scanner for 900 nm & 930 nm SD-OCT Systems, Imperial	\$12,730.80	Lead Time

### Scan Lens Kit (Required OCT System Component)

- ▶ Telecentric Scan Lenses Provide a Flat Imaging Plane
- ▶ Lens AR Coated for 800 - 1100 nm

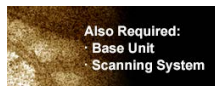

To be

The cross-section image below of a banana was taken with the OCT-LK3-BB scan lens kit using a Callisto Series OCT system. Choose a scan lens kit that provides the right resolution and focal length for your

- ▶ Scan Lens Kits for Standard / User-Customizable Scanners Include
  - ▶ Telecentric Scan Lens
  - ▶ Illumination Tube
  - ▶ IR Card
  - ▶ Calibration Target
- ▶ Compact Scan Lens Kits Designed for the OCTH-900 Handheld Scanner with Integrated Scan Lens and Illumination Ring

functional, an OCT system build must include a base unit, a scanning system, and a scan lens kit. application.

OCT-LK3-BB (36 mm Focal length)

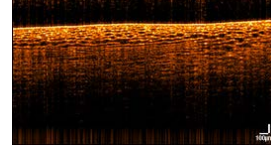

Click to Enlarge  
Magnification: 5X  
Scan Region: 3 mm x 1.7 mm  
Lateral Resolution: 8 μm

Thorlabs' Scan Lens Kits enable easy exchange of scan lenses in an OCT system, providing the flexibility to tailor imaging resolution or working distance for each application. Based on our line of OCT telecentric scan lenses, these lens kits minimize image distortion without extensive post-image processing and maximize coupling of the light scattered or emitted from the sample surface into the detection system. As seen in the table below, we offer scan lens kits compatible with the standard (Item # OCTG-900) and user-customizable (Item # OCTP-900) scanners, as well as two lens kits compatible with the handheld scanner (Item # OCTH-900).

Each kit includes a telecentric scan lens, illumination tube, IR card, and calibration target. The included illumination tube serves as a light guide that channels light from the LED illumination ring down to the sample area. The IR card and calibration target are provided for calibration of the scanning mirror and lens kit, ensuring the best image quality when swapping between scan lenses.

Item #	OCT-LK2-BB	OCT-LK3-BB	OCT-LK4-BB	OCTH-LK20-BB	OCTH-LK30-BB
Click Image to Enlarge					
Design Wavelength	900 nm / 930 nm			900 nm / 930 nm	
Compatible Scanner	OCTG-900 (Standard) or OCTP-900 (User-Customizable)			OCTH-900 Handheld Scanner	
Lateral Resolution <sup>a</sup>	4 μm	8 μm	12 μm	9 μm	14 μm
Focal Length	18 mm	36 mm	54 mm	20 mm	30 mm
Working Distance	3.4 mm (with Tube) <sup>b</sup> 7.5 mm (without Tube)	24.9 mm (with Tube) <sup>b</sup> 25.1 mm (without Tube)	41.6 mm (with Tube) <sup>b</sup> 42.3 mm (without Tube)	12 mm	22 mm
Field of View	6 mm x 6 mm	10 mm x 10 mm	16 mm x 16 mm	Ø8 mm	Ø10 mm
Lens Threading	M25 x 0.75	M25 x 0.75	M25 x 0.75	M20 x 0.5 (For Z-Spacer) M14 x 0.5 (For OCTH-900)	

- a.  $1/e^2$  Beam Diameter at Focus
- b. The illumination tube is user-removable.

Part Number	Description	Price	Availability
OCT-LK2-BB	OCT Scan Lens Kit, 18 mm FL, 900 nm / 930 nm	\$2,056.02	Lead Time
OCT-LK3-BB	OCT Scan Lens Kit, 36 mm FL, 900 nm / 930 nm	\$1,406.75	Lead Time
OCT-LK4-BB	OCT Scan Lens Kit, 54 mm FL, 900 nm / 930 nm	\$1,406.75	Lead Time
OCTH-LK20-BB	OCT Scan Lens Kit for OCTH-900, 20 mm FL, 900 nm / 930 nm	\$1,071.29	Lead Time
OCTH-LK30-BB	OCT Scan Lens Kit for OCTH-900, 30 mm FL, 900 nm / 930 nm	\$1,071.29	Lead Time

### Reference Length Adapters (Required for Standard Scanners)

- ▶ Arm Adapters for Matching Reference Path Length to the Sample Path Length
- ▶ Use Multiple Reference Adapters for Rapid Switching Between Scan Lens Kits
- ▶ Must be Purchased with Standard Scanner (Item # OCTG-900)

Item # <sup>a</sup>	Compatible Scan Lens Kit
OCT-RA2	OCT-LK2-BB
OCT-RA3	OCT-LK3-BB
OCT-RA4	OCT-LK4-BB

These adapters adjust the reference arm path length within the OCTG-900 Standard Scanner to match the sample path length of the scan lens used. Choose from three options that are compatible with the scan lens kits sold above. Reference length adapters also enable the user to quickly swap between different scan lens kits without going through extensive adjustments during each switch. The table to the right provides a compatibility list to help select the appropriate reference adapters.

- Multiple reference adapters can be purchased for rapid switching between scan lens kits.

Part Number	Description	Price	Availability
OCT-RA2	Length Adapter for SD-OCT Standard Scanner & OCT-LK2(-BB) Scan Lens Kit	\$551.88	Lead Time
OCT-RA3	Length Adapter for SD-OCT Standard Scanner & OCT-LK3(-BB) Scan Lens Kit	\$551.88	Lead Time
OCT-RA4	Length Adapter for SD-OCT Standard Scanner & OCT-LK4(-BB) Scan Lens Kit	\$551.88	Lead Time

### Sample Z-Spacers (Optional Accessories)



Click to Enlarge Z-Spacers for the OCTG-900 and OCTP-900(M) Scanners

- ▶ Sample Z-Spacers Position Scanner at Optimal Working Distance From Sample
- ▶ Ring (Air) and Immersion (Liquid) Z-Spacers Available
- ▶ Two Z-Spacers Recommended for Use with OCTH-900 Handheld Scanner

Thorlabs offers both ring and immersion style sample Z-spacers that enable optimal positioning of a scanning system relative to the sample. The OCT-AIR3, OCT-IMM3, and OCT-IMM4 Z-Spacers feature knurled rings that allow the spacing distance to be adjusted and locked in place for increased stability. Several Z-spacer options are available; please see the table below for compatibility with our scanners and lens kits.



Click to Enlarge Z-Spacers for the OCTH-900 Handheld Scanner

Additionally, we offer two ring-style Z-spacers that are designed specifically for the OCTH-900 Handheld Scanner; these spacers greatly assist in maintaining the correct sample working distance when using the handheld scanner. The spacing distance on the OCTH-AIR20 and OCTH-AIR30 Z-Spacers can be adjusted by rotating the spacer.

Our ring-style Z-spacers provide a distance guide between the scanner and sample. The sample is in contact with the ring-shaped tip of the spacer and should only be used when air is the scanning medium. In contrast, our immersion spacers are equipped with a glass plate that contacts the sample surface within the scanning area. Unlike the ring-style spacers, immersion spacers enable access to samples contained within a liquid environment while also providing sample stabilization. Better index matching and a tilted glass plate also help reduce strong back reflections from the sample surface and enhances the contrast of the image.

Item # <sup>a</sup>	Type	Adjustable	Adjustment Range	Lockable	Compatible Scanner	Compatible Scan Lens Kit
OCT-AIR3	Ring (Air)	Yes	+3.5 mm / -1.0 mm	Yes	OCTG-900 OCTP-900(M)	OCT-LK3-BB
OCT-IMM3	Immersion	Yes	+3.4 mm / -1.1 mm	Yes		OCT-LK4-BB
OCT-IMM4	Immersion	Yes	+1.0 mm / -17.0 mm	Yes		OCT-LK4-BB
OCTH-AIR20	Ring (Air)	Yes	±4 mm	No	OCTH-900 <sup>a</sup>	OCTH-LK20-BB
OCTH-AIR30	Ring (Air)	Yes	±2 mm	No		OCTH-LK30-BB

- a. We recommend purchasing a sample Z-spacer if using the OCTH-900 handheld scanner.

Part Number	Description	Price	Availability
OCT-AIR3	Ring-Style Sample Z-Spacer for OCT-LK3(-BB) Scan Lens Kit	\$772.63	Lead Time
OCT-IMM3	Immersion-Style Sample Z-Spacer for OCT-LK3(-BB) Scan Lens Kit	\$938.20	Lead Time
OCT-IMM4	Immersion-Style Sample Z-Spacer for OCT-LK4(-BB) Scan Lens Kit	\$1,048.57	Lead Time
OCTH-AIR20	Ring-Style Sample Z-Spacer for OCTH-LK20(-BB) Scan Lens Kit	\$199.11	Lead Time
OCTH-AIR30	Ring-Style Sample Z-Spacer for OCTH-LK30(-BB) Scan Lens Kit	\$199.11	Lead Time

### Scanner Stand (Optional Accessory)

- ▶ Recommended Stand for Mounting Standard or User-Customizable Scanners
- ▶ Focus Block with Coarse/Fine Z-Axis Travel on Ø1.5" Stainless Steel Post
- ▶ 12" x 14" (300 mm x 350 mm) Aluminum Breadboard with 1/4"-20 (M6) Tapped Holes

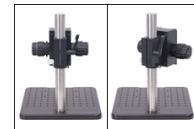

Click for Details  
The focus block can be rotated 45° to move the scanner head away from the sample.

For convenient mounting of our Standard or User-Customizable Scanners, we offer a scanner stand that is ideal for use in vibration-sensitive studies such as angiography. It consists of a post-mounted focus block with knobs that provide both coarse (40 mm/rev) and fine (225 µm/rev) z-axis travel. A rotation and height collar underneath the focus block allows it to rotate 45° in order to move the scanner head away from the sample to make adjustments.

The focus block attaches to a 12" x 14" (300 mm x 350 mm) aluminum breadboard via the included Ø1.5" post. The aluminum breadboard has side grips and rubber feet for easy lifting and transportation. There is an array of 1/4"-20 (M6) tapped holes for mounting optomechanics. Four extra 1/4"-20 (M6) tapped holes allow the mounting of the OCT-XYR1 Translation Stage (sold below) to the OCT-STAND and the OCT-XYR1/M Translation Stage to the OCT-STAND/M directly underneath the scan lens. A 1/4"-20 (M6) counterbore is also provided for securing the Ø1.5" post.

Part Number	Description	Price	Availability
OCT-STAND/M	Stand for Standard and User-Customizable OCT Scanning Systems, M6 Tapped Holes	\$2,164.24	5-8 Days
OCT-STAND	Stand for Standard and User-Customizable OCT Scanning Systems, 1/4"-20 Tapped Holes	\$2,164.24	Lead Time

### Translation Stage (Optional Accessory)

- ▶ Optional Translation Stage with 0.5" (13 mm) of XY Travel and 360° Rotation
- ▶ Includes Cover Plate for Sample Mounting
- ▶ Can Mount Optomechanics by Removing Cover Plate

Specifications	
Horizontal Load Capacity (Max)	10 lbs (4.5 kg)
Mounting Platform Dimensions	Ø4.18" (Ø106 mm)
Stage Height	1.65" (41.8 mm)
Linear Translation Range	1/2" (13 mm)
Travel per Revolution	0.025" (0.5 mm)
Graduation	0.001" (10 µm) per Division



Click to Enlarge  
The cover plate is removable for access to tapped holes and the SM1-threaded central hole.

Precise translation and rotation are often required for optimal positioning of a sample before and during OCT imaging. The OCT-XYR1(M) is an XY linear translation stage with a rotating platform and solid plate for sample mounting and easy cleaning. The OCT-XYR1 or OCT-XYR1/M stage can be secured to the OCT-STAND or OCT-STAND/M, respectively, using the 1/4" (M6) counterbores at the corners. The top plate is removable for access to 4-40, 8-32 (M4), and 1/4"-20 (M6) tapped holes and an SM1-threaded (1.035"-40) central hole for mounting optomechanical components. The XYR1A Solid Sample Plate can be purchased separately as a direct replacement for the top plate.

The X and Y micrometers offer 1/2" (13 mm) of travel with graduations every 0.001" (10  $\mu$ m). The stage's rotation and translation can be freely changed without compromising the stability of attached components. An engraved angular scale along the outer edge of the stage's rotating platform allows the user to set the angular orientation of the stage, which can then be fixed using the 5/64" (2 mm) hex locking setscrew. Locking the rotation of the stage does not prevent XY translation using the actuators.

Part Number	Description	Price	Availability
OCT-XYR1/M	XY Stage with Solid Top Plate, 13 mm Travel, 360° Rotation, Metric Taps	\$772.63	Today
OCT-XYR1	XY Stage with Solid Top Plate, 1/2" Travel, 360° Rotation, Imperial Taps	\$772.63	5-8 Days

