

56 Sparta Avenue • Newton, New Jersey 07860  
 (973) 300-3000 Sales • (973) 300-3600 Fax  
 www.thorlabs.com



## L915P1WJ - July 30, 2015

Item # L915P1WJ was discontinued on July 30, 2015. For informational purposes, this is a copy of the website content at that time and is valid only for the stated product.

### LASER DIODES, Ø3.8 MM, Ø5.6 MM, Ø9 MM, Ø9.5 MM, AND TO-46 TO CANS

- ▶ Ø3.8 mm, Ø5.6 mm, Ø9 mm, Ø9.5 mm, and TO-46 Laser Diodes
- ▶ Central Wavelengths Ranging from 375 to 1650 nm
- ▶ Output Powers from 1.85 mW to 2 W



[Hide Overview](#)

## OVERVIEW

### Features

- Fabry-Perot (FP), Distributed Feedback (DFB), Volume Holographic Grating (VHG), Vertical-Cavity Surface-Emitting (VCSEL), and Diode-Pumped Solid-State (DPSS) Laser Diodes
- Output Powers from 1.85 mW to 2 W
- Center Wavelengths Available from 375 nm to 1650 nm
- Easily Choose a Compatible Mount Using Our LD Pin Codes
- Compatible with Thorlabs' Laser Diode and TEC Controllers

TO-packaged laser diodes are available in standard Ø3.8 mm, Ø5.6 mm, or Ø9 mm TO cans, as well as Ø9.5 mm and TO-46 cans. We have categorized the pin configurations into standard A, B, C, D, E, F, G, and H pin codes (see the diagram below). This pin code allows the user to easily determine compatible mounts.

Some of our diodes that are offered in header packages can be converted to a sealed TO can package by request, as indicated in the tables below. Please contact Tech Support for details.

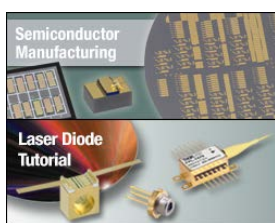

### Laser Diode Selection Guide



Shop by Wavelength	UV (375 nm)
	Visible (404 nm - 690 nm) NIR (705 nm - 2000 nm) MIR (3.42 µm - 9.60 µm)
Shop by Package/Type	TO Can (Ø3.8, Ø5.6, Ø9, and Ø9.5 mm) TO Can Pigtail (SM) TO Can Pigtail (PM) TO Can Pigtail (MM) FP Butterfly Package FBG-Stabilized Butterfly Package Chip on Submount MIR Fabry-Perot Two-Tab C-Mount One-Tab C-Mount
	<b>Single Frequency Lasers</b>
	DFB Single-Frequency TO Can Pigtail (SM) VHG-Stabilized Single-Frequency ECL Single-Frequency Butterfly Package DBR Single-Frequency Butterfly Package MIR DFB Two-Tab C-Mount



Click to Enlarge  
Ø9 mm TO-Can Laser Diode Secured in Post-Mounted LM9F Holder

### Notes on Center Wavelength

While the center wavelength is listed for each diode, this is only a typical number. The center wavelength of a particular diode varies from production run to production run. Thus, the diode you receive may not operate at the typical center wavelength. Diodes can be temperature tuned, which will alter the lasing wavelength. A number of diodes are listed as Wavelength Tested, which means that each diode has been tested and the dominant wavelength has been recorded. Customers may contact Tech

Webpage Features	
	Clicking this icon opens a window that contains specifications and mechanical drawings.
	Clicking this icon allows you to download our standard support documentation.
<a href="#">Choose Item</a>	Clicking the words "Choose Item" opens a drop-down list containing all of the in-stock lasers around the desired center wavelength. The red icon next to the serial number then allows you to download L-I-V and spectral measurements for that serial-numbered device.

Support to select one of these diodes based on the tested wavelength. For the LD785-SE400, LD785-SH300, and LD785-SEV300, after clicking "Choose Item" below, a list will appear that contains the dominant wavelength, output power, and operating current of each in-stock unit. Clicking on the red Docs Icon next to the serial number provides access to a PDF with serial-number-specific L-I-V and spectral characteristics.

### Spatial Mode and Linewidth

We offer laser diodes with different output characteristics (power, wavelength, beam size, shape, etc.). Most lasers offered here are single spatial mode ("single mode") and a few are designed for higher-power multi-spatial-mode ("multimode") operation. Some single mode laser diodes can be operated with limited single-longitudinal-mode characteristics. For better side mode suppression ratio (SMSR) performance, other devices such as DFB lasers, DBR lasers, or external cavity lasers should be considered. Please see our Laser Diode Tutorial for more information on these topics and laser diodes in general.

Laser diodes are sensitive to electrostatic shock. Please take the proper precautions when handling the device, such as using an ESD wrist strap. These lasers are also sensitive to optical feedback, which can cause significant fluctuations in the output power of the laser diode depending on the application. Members of our Tech Support staff are available to help you select a laser diode and to discuss possible operation issues.

### Pin Codes



For warranty information and the Thorlabs Life Support and Military Use Policy for laser diodes, please refer to the *LD Operation* tab.

[Hide Collimation Tutorial](#)

## COLLIMATION TUTORIAL

### Choosing a Collimation Lens for Your Laser Diode

Since the output of a laser diode is highly divergent, collimating optics are necessary. Since aspheric lenses do not introduce spherical aberration, they are commonly chosen when the collimated laser beam is to be between one and five millimeters. A simple example will illustrate the key specifications to consider when choosing the correct lens for a given application.

Example:

Laser Diode to be Used: L780P010

Desired Collimated Beam Diameter: Ø3 mm (Major Axis)

The specifications for the L780P010 laser diode indicate that the typical parallel and perpendicular FWHM beam divergences are 10° and 30°, respectively. Therefore, as the light diverges, an elliptical beam will result. To collect as much light as possible during the collimation process, consider the larger of these two divergence angles in any calculations (i.e., in this case use 30°). If you wish to convert your elliptical beam in to a round one, we suggest using an Anamorphic Prism Pair, which magnifies one axis of your beam.

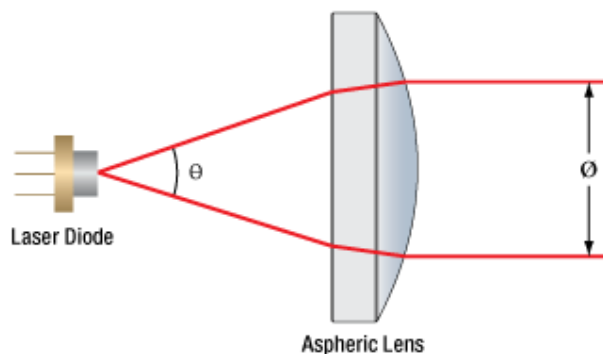

$\varnothing$  = Beam Diameter     $\Theta$  = Divergence Angle

From the information above, the focal length of the lens can be determined, using the thin lens approximation:

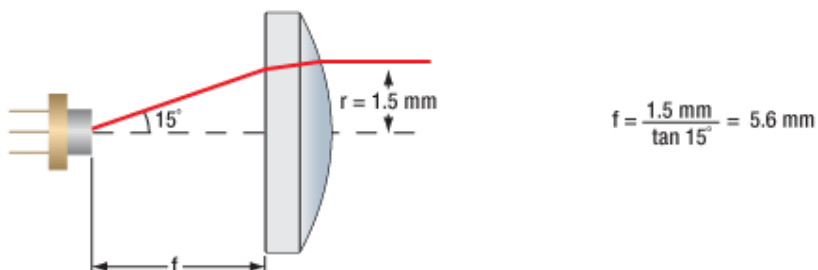

With this information known, it is now time to choose the appropriate collimating lens. Thorlabs offers a large selection of aspheric lenses to choose from. For this application the ideal lens is a -B AR-coated molded glass aspheric lens with focal length near 5.6 mm. The C171TMD-B (mounted) or 354171-B (unmounted) aspheric lenses have a focal length of 6.20 mm, which will result in a collimated beam diameter (major axis) of 3.3 mm. Next, check to see if the numerical aperture (NA) of the diode is smaller than the NA of the lens:

$$0.30 = \text{NA}_{\text{Lens}} > \text{NA}_{\text{Diode}} \approx \sin(15^\circ) = 0.26$$

Up to this point, we have been using the FWHM beam diameter to characterize the beam. However, a better practice is to use the  $1/e^2$  beam diameter. For a Gaussian beam profile, the  $1/e^2$  diameter is almost equal to 1.7X the FWHM diameter. The  $1/e^2$  beam diameter therefore captures more of the laser diode's output light (for greater power delivery) and minimizes far-field diffraction (by clipping less of the incident light).

A good rule of thumb is to pick a lens with an NA twice of the NA of the laser diode. For example, either the A390-B or the A390TM-B could be used as these lenses each have an NA of 0.53, which is more than twice the approximate NA of our laser diode (0.26). Note that these lenses each have a focal length of 4.6 mm, resulting in an approximate major beam diameter of 2.5 mm.

[Hide LD Operation](#)

## LD OPERATION

### Laser Diode and Laser Diode Pigtail Warranty

When operated within their specifications, laser diodes have extremely long lifetimes. Most failures occur from mishandling or operating the lasers beyond their maximum ratings. Laser Diodes are among the most static-sensitive devices currently made. Proper ESD Protection should be worn whenever handling a laser diode. Due to their extreme electrostatic sensitivity, laser diodes cannot be returned after their sealed package has been open. Laser diodes in their original sealed package can be returned for a full refund or credit.

### Handling and Storage Precautions

Due to their extreme susceptibility to damage from electrostatic discharge (ESD), care should be taken whenever handling and operating laser diodes:

- Wrist Straps: Use grounded anti-static wrist straps whenever handling diodes.
- Anti-Static Mats: Always work on grounded anti-static mats.

- Laser Diode Storage: When not in use, short the leads of the laser together to protect against ESD damage.

## Operating and Safety Precautions

### Use an Appropriate Driver:

Laser diodes require precise control of operating current and voltage to avoid overdriving the laser diode. In addition, the laser driver should provide protection against power supply transients. Select a laser driver appropriate for your application. Do not use a voltage supply with a current limiting resistor since it does not provide sufficient regulation to protect the laser.

### Power Meters:

When setting up and calibrating a laser diode with its driver, use a NIST-traceable power meter to precisely measure the laser output. It is usually safest to measure the laser output directly before placing the laser in an optical system. If this is not possible, be sure to take all optical losses (transmissive, aperture stopping, etc.) into consideration when determining the total output of the laser.

### Reflections:

Flat surfaces in the optical system in front of a laser diode can cause some of the laser energy to reflect back onto the laser's monitor photodiode giving an erroneously high photodiode current. If optical components are moved within the system and energy is no longer reflected onto the monitor photodiode, a constant power feedback loop will sense the drop in photodiode current and try to compensate by increasing the laser drive current and possibly overdriving the laser. Back reflections can also cause other malfunctions or damage to laser diodes. To avoid this, be sure that all surfaces are angled 5-10°, and when necessary, use optical isolators to attenuate direct feedback into the laser.

### Heat Sinks:

Laser diode lifetime is inversely proportional to operating temperature. Always mount the laser in a suitable heat sink to remove excess heat from the laser package.

### Voltage and Current Overdrive:

Be careful not to exceed the maximum voltage and drive current listed on the specification sheet with each laser diode, even momentarily. Also, reverse voltages as little as 3 V can damage a laser diode.

### ESD Sensitive Device:

Currently operating lasers are susceptible to ESD damage. This is particularly aggravated by using long interface cables between the laser diode and its driver due to the inductance that the cable presents. Avoid exposing the laser or its mounting apparatus to ESDs at all times.

### ON/OFF and Power Supply Coupled Transients:

Due to their fast response times, laser diodes can be easily damaged by transients less than 1  $\mu$ s. High current devices such as soldering irons, vacuum pumps, and fluorescent lamps can cause large momentary transients. Thus, always use surge-protected outlets.

If you have any questions regarding laser diodes, please call your local Thorlabs Technical Support office for assistance.

## Life Support and Military Use Application Policy

Thorlabs' products are not authorized for use as critical components in life support devices or systems or in any military applications without the express written approval of the president of Thorlabs:

1. Life support devices or systems are devices or systems intended for either surgical implantation into the body or to sustain life and whose failure to perform, when properly used in accordance with instructions for use provided in the labeling, can be reasonably expected to result in a significant injury to the user.
2. A critical component is any component in a life support device or system whose failure to perform can be reasonably expected to cause the failure of the life support device or system or to affect its safety or effectiveness.
3. Thorlabs' laser diodes are not intended nor warranted for usage in Military Applications.

[Hide Laser Safety](#)

## LASER SAFETY

## Laser Safety and Classification

Safe practices and proper usage of safety equipment should be taken into consideration when operating lasers. The eye is susceptible to injury, even from very low levels of laser light. Thorlabs offers a range of laser safety accessories that can be used to reduce the risk of accidents or injuries. Laser emission in the visible and near infrared spectral ranges has the greatest potential for retinal injury, as the cornea and lens are transparent to those wavelengths, and the lens can focus the laser energy onto the retina.





### Safe Practices and Light Safety Accessories

- Thorlabs recommends the use of safety eyewear whenever working with laser beams with non-negligible powers (i.e., > Class 1) since metallic tools such as screwdrivers can accidentally redirect a beam.
- Laser goggles designed for specific wavelengths should be clearly available near laser setups to protect the wearer from unintentional laser reflections.
- Goggles are marked with the wavelength range over which protection is afforded and the minimum optical density within that range.
- Laser Barriers and Blackout Materials can prevent direct or reflected light from leaving the experimental setup area.
- Thorlabs' Enclosure Systems can be used to contain optical setups to isolate or minimize laser hazards.
- A fiber-pigtailed laser should always be turned off before connecting it to or disconnecting it from another fiber, especially when the laser is at power levels above 10 mW.
- All beams should be terminated at the edge of the table, and laboratory doors should be closed whenever a laser is in use.
- Do not place laser beams at eye level.
- Carry out experiments on an optical table such that all laser beams travel horizontally.
- Remove unnecessary reflective items such as reflective jewelry (e.g., rings, watches, etc.) while working near the beam path.
- Be aware that lenses and other optical devices may reflect a portion of the incident beam from the front or rear surface.
- Operate a laser at the minimum power necessary for any operation.
- If possible, reduce the output power of a laser during alignment procedures.
- Use beam shutters and filters to reduce the beam power.
- Post appropriate warning signs or labels near laser setups or rooms.
- Use laser sign lightboxes if operating Class 3R or 4 lasers (i.e., lasers requiring the use of a safety interlock).
- Do not use Laser Viewing Cards in place of a proper Laser Barrier or Beam Trap.



## Laser Classification

Lasers are categorized into different classes according to their ability to cause eye and other damage. The International Electrotechnical Commission (IEC) is a global organization that prepares and publishes international standards for all electrical, electronic, and related technologies. The IEC document 60825-1 outlines the safety of laser products. A description of each class of laser is given below:

Class	Description	Warning Label
1	This class of laser is safe under all conditions of normal use, including use with optical instruments for intrabeam viewing. Lasers in this class do not emit radiation at levels that may cause injury during normal operation, and therefore the maximum permissible exposure (MPE) cannot be exceeded. Class 1 lasers can also include enclosed, high-power lasers where exposure to the radiation is not possible without opening or shutting down the laser.	
1M	Class 1M lasers are safe except when used in conjunction with optical components such as telescopes and microscopes. Lasers belonging to this class emit large-diameter or divergent beams, and the MPE cannot normally be exceeded unless focusing or imaging optics are used to narrow the beam. However, if the beam is refocused, the hazard may be increased and the class may be changed accordingly.	
2	Class 2 lasers, which are limited to 1 mW of visible continuous-wave radiation, are safe because the blink reflex will limit the exposure in the eye to 0.25 seconds. This category only applies to visible radiation (400 - 700 nm).	
2M	Because of the blink reflex, this class of laser is classified as safe as long as the beam is not viewed through optical instruments. This laser class also applies to larger-diameter or diverging laser beams.	
3R	Lasers in this class are considered safe as long as they are handled with restricted beam viewing. The MPE can be exceeded with this class of laser, however, this presents a low risk level to injury. Visible, continuous-wave lasers are limited to 5 mW of output power in this class.	
3B	Class 3B lasers are hazardous to the eye if exposed directly. However, diffuse reflections are not harmful. Safe handling of devices in this class includes wearing protective eyewear where direct viewing of the laser beam may occur. In addition, laser safety signs lightboxes should be used with lasers that require a safety interlock so that the laser cannot be used without the safety light turning on. Class-3B lasers must be equipped with a key switch and a safety interlock.	
4	This class of laser may cause damage to the skin, and also to the eye, even from the viewing of diffuse reflections. These hazards may also apply to indirect or non-specular reflections of the beam, even from apparently matte surfaces. Great care must be taken when handling these lasers. They also represent a fire risk, because they may ignite combustible material. Class 4 lasers must be equipped with a key switch and a safety interlock.	
All class 2 lasers (and higher) must display, in addition to the corresponding sign above, this triangular warning sign		

The content that appeared below this point on the webpage has been condensed to highlight the information available for the LP915P1WJ at the time it was discontinued. Up-to-date information on other laser diodes that appeared on this page can be found by visiting [www.thorlabs.com](http://www.thorlabs.com).

[Hide 904 nm - 940 nm TO Can Laser Diodes](#)

### 904 nm - 940 nm TO Can Laser Diodes

Item #	Info	Wavelength (nm)	Power (mW)	Typical/Max Drive Current	Package	Pin Code	Monitor Photodiode <sup>a</sup>	Compatible Socket	Wavelength Tested	Spatial Mode
L904P010		904	10	50 mA / 70 mA	Ø5.6 mm	A	Yes	S7060R	No	Single Mode
M5-905-0100		905	100	140 mA / 170 mA	Ø5.6 mm	A	Yes	S7060R	No	Single Mode
M9-915-0200		915	200	260 mA / 300 mA	Ø9 mm	A	Yes	S8060 or S8060-4	No	Single Mode
M9-915-0300		915	300	370 mA / 420 mA	Ø9 mm	A	Yes	S8060 or S8060-4	No	Single Mode
L915P1WJ		915	1000	1500 mA / 1800 mA	Ø9 mm	A	Yes	S8060 or S8060-4	No	Multimode
M9-940-0100		940	100	140 mA / 180 mA	Ø9 mm	A	Yes	S8060 or S8060-4	No	Single Mode
M9-940-0200		940	200	270 mA / 320 mA	Ø9 mm	A	Yes	S8060 or S8060-4	No	Single Mode
M9-940-0300		940	300	400 mA / 450 mA	Ø9 mm	A	Yes	S8060 or S8060-4	No	Single Mode

a. Laser diodes with a built-in monitor photodiode can operate at constant power.

Part Number	Description	Price	Availability
L904P010	904 nm, 10 mW, Ø5.6 mm, A Pin Code, Laser Diode	\$25.00 Volume Pricing Available	Today
M5-905-0100	905 nm, 100 mW, Ø5.6 mm, A Pin Code, Laser Diode	\$297.28 Volume Pricing Available	Today
M9-915-0200	915 nm, 200 mW, Ø9 mm, A Pin Code, Laser Diode	\$697.74 Volume Pricing Available	Today
M9-915-0300	915 nm, 300 mW, Ø9 mm, A Pin Code, Laser Diode	\$1,056.34 Volume Pricing Available	Today
L915P1WJ	915 nm, 1000 mW, Ø9 mm, A Pin Code, MM, Laser Diode	\$380.70 Volume Pricing Available	Lead Time
M9-940-0100	940 nm, 100 mW, Ø9 mm, A Pin Code, Axcel Laser Diode	\$297.52 Volume Pricing Available	3-5 Days
M9-940-0200	940 nm, 200 mW, Ø9 mm, A Pin Code, Axcel Laser Diode	\$566.76 Volume Pricing Available	Today
M9-940-0300	940 nm, 300 mW, Ø9 mm, A Pin Code, Axcel Laser Diode	\$850.00 Volume Pricing Available	3-5 Days

## Specifications

## Drawings

**Optical Electrical Characteristics ( $T_{CASE} = 25\text{ }^{\circ}\text{C}$ ,  $P = 1000\text{ mW}$ )**

Characteristic	MIN	TYP	MAX	UNIT
Lasing Wavelength	905	915	925	nm
Operating Voltage	-	1.5	1.8	V
Beam Divergence (FWHM) - Parallel	3	5	7	deg.
Beam Divergence (FWHM) - Perpendicular	26	31	36	deg.
Operating Current	-	1.5	1.8	A
Threshold Current	-	450	650	mA
Monitor Current	0.05	-	10	mA
Slope Efficiency	0.85	1	-	mW/mA

**Absolute Maximum Ratings<sup>a</sup>**

Characteristic		
Optical Output Power (CW)	1	W
LD Reverse Voltage	2	V
PD Reverse Voltage	20	V
Operation Case Temperature	-20 to 40	$^{\circ}\text{C}$
Storage Temperature	-40 to 85	$^{\circ}\text{C}$

- a. Absolute Maximum Rating specifications should never be exceeded. Operating beyond these conditions can seriously damage the laser. For more information, please see the [Laser Diode Tutorial](#).



L915P1WJ - 915 nm, 1000 mW, Ø9 mm, A Pin Code, Laser Diode



Specifications

Drawings

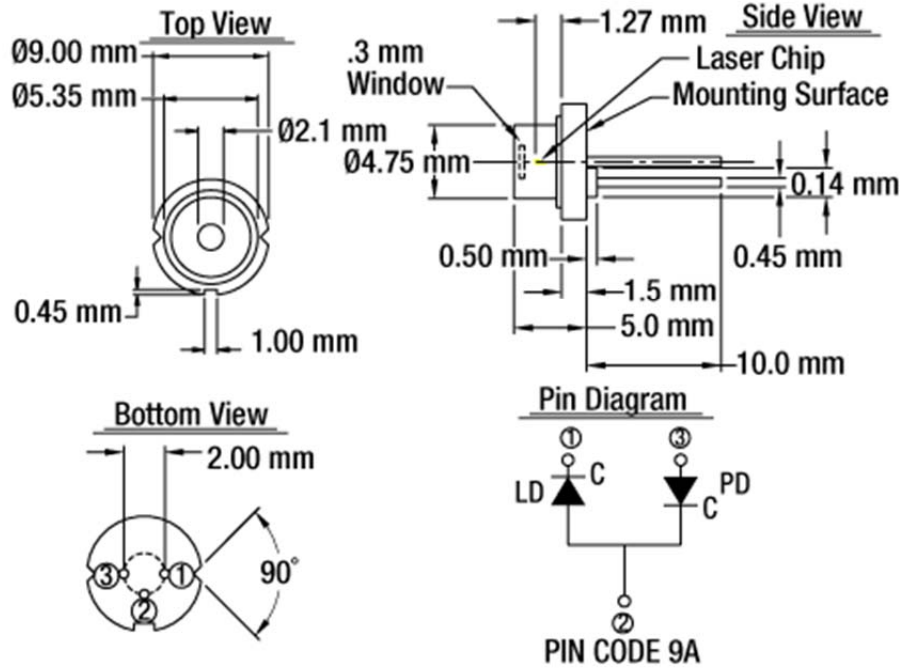

L915P1WJ - 915 nm, 1000 mW, Ø9 mm, A Pin Code, Laser Diode